

# OPERATION MANUAL





## **MODEL MQP240 60HZ GENERATOR (CUMMINS QSL9-G3 DIESEL ENGINE)**

Revision #2 (01/18/18)

To find the latest revision of this  
publication, visit our website at:  
[www.multiquip.com](http://www.multiquip.com)



**THIS MANUAL MUST ACCOMPANY THE EQUIPMENT AT ALL TIMES.**

 <b>WARNING</b> 
<b>CALIFORNIA — Proposition 65 Warning</b>
Diesel engine exhaust and some of its constituents are known to the State of California to cause cancer, birth defects and other reproductive harm.

## **MQP240 60 Hz Generator**

Proposition 65 Warning .....	2
Safety Information .....	4-9
Specifications .....	10
Dimensions.....	11
Installation .....	12-13
General Information.....	14
Major Components .....	15
Generator Control Panel.....	16-17
Engine Operating Panel.....	18
Output Terminal Panel Familiarization .....	20-22
Load Application .....	23
Generator Outputs.....	24-25
Gauge Reading .....	25
Output Terminal Panel Connections .....	26-27
Inspection/Setup.....	28-31
Generator Start-Up Procedure (Manual) .....	32-33
Generator Start-Up Procedure (Auto Mode).....	34
Generator Shut-Down Procedures .....	35
Maintenance .....	36-39
Generator Wiring Diagram.....	40
Engine Wiring Diagram.....	41
Troubleshooting (Generator).....	42
Troubleshooting (Engine Controller) .....	43
Troubleshooting (Diagnostic Lamp) .....	44

### **NOTICE**

Specifications are subject to change without notice.

# SAFETY INFORMATION

Do not operate or service the equipment before reading the entire manual. Safety precautions should be followed at all times when operating this equipment. Failure to read and understand the safety messages and operating instructions could result in injury to yourself and others.

## SAFETY MESSAGES

The four safety messages shown below will inform you about potential hazards that could injure you or others. The safety messages specifically address the level of exposure to the operator and are preceded by one of four words: **DANGER**, **WARNING**, **CAUTION** or **NOTICE**.

## SAFETY SYMBOLS

 **DANGER**

Indicates a hazardous situation which, if not avoided, **WILL** result in **DEATH** or **SERIOUS INJURY**.

 **WARNING**

Indicates a hazardous situation which, if not avoided, **COULD** result in **DEATH** or **SERIOUS INJURY**.







 **CAUTION**

Indicates a hazardous situation which, if not avoided, **COULD** result in **MINOR** or **MODERATE INJURY**.

**NOTICE**

Addresses practices not related to personal injury.

Potential hazards associated with the operation of this equipment will be referenced with hazard symbols which may appear throughout this manual in conjunction with safety messages.

Symbol	Safety Hazard
	Lethal exhaust gas hazards
	Explosive fuel hazards
	Burn hazards
	Overspeed hazards
	Rotating parts hazards
	Pressurized fluid hazards
	Electric shock hazards

# SAFETY INFORMATION

## GENERAL SAFETY

### CAUTION

- **NEVER** operate this equipment without proper protective clothing, shatterproof glasses, respiratory protection, hearing protection, steel-toed boots and other protective devices required by the job or city and state regulations.



- **NEVER** operate this equipment when not feeling well due to fatigue, illness or when under medication.



- **NEVER** operate this equipment under the influence of drugs or alcohol.



- **ALWAYS** check the equipment for loosened threads or bolts before starting.
- **DO NOT** use the equipment for any purpose other than its intended purposes or applications.

### NOTICE

- This equipment should only be operated by trained and qualified personnel 18 years of age and older.
- Whenever necessary, replace nameplate, operation and safety decals when they become difficult read.
- Manufacturer does not assume responsibility for any accident due to equipment modifications. Unauthorized equipment modification will void all warranties.

- **NEVER** use accessories or attachments that are not recommended by MQ Power for this equipment. Damage to the equipment and/or injury to user may result.

- **ALWAYS** know the location of the nearest **fire extinguisher**.



- **ALWAYS** know the location of the nearest **first aid kit**.



- **ALWAYS** know the location of the nearest phone or **keep a phone on the job site**. Also, know the phone numbers of the nearest **ambulance, doctor and fire department**. This information will be invaluable in the case of an emergency.



## GENERATOR SAFETY

### DANGER

- **NEVER** operate the equipment in an explosive atmosphere or near combustible materials. An explosion or fire could result causing severe **bodily harm or even death**.



### WARNING

- **NEVER** disconnect any **emergency or safety devices**. These devices are intended for operator safety. Disconnection of these devices can cause severe injury, bodily harm or even death. Disconnection of any of these devices will void all warranties.

### CAUTION

- **NEVER** lubricate components or attempt service on a running machine.

### NOTICE

- **ALWAYS** ensure generator is on level ground before use.
- **ALWAYS** keep the machine in proper running condition.
- Fix damage to machine and replace any broken parts immediately.
- **ALWAYS** store equipment properly when it is not being used. Equipment should be stored in a clean, dry location out of the reach of children and unauthorized personnel

# SAFETY INFORMATION

## ENGINE SAFETY

### DANGER

- The engine fuel exhaust gases contain poisonous carbon monoxide. This gas is colorless and odorless, and can cause death if inhaled.
- The engine of this equipment requires an adequate free flow of cooling air. **NEVER** operate this equipment in any enclosed or narrow area where free flow of the air is restricted. If the air flow is restricted it will cause injury to people and property and serious damage to the equipment or engine.

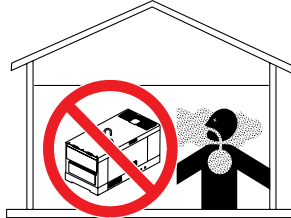

### WARNING

- **DO NOT** place hands or fingers inside engine compartment when engine is running.
- **NEVER** operate the engine with heat shields or guards removed.
- Keep fingers, hands hair and clothing away from all moving parts to prevent injury.
- **DO NOT** remove the radiator cap while the engine is hot. High pressure boiling water will gush out of the radiator and severely scald any persons in the general area of the generator.
- **DO NOT** remove the coolant drain plug while the engine is hot. Hot coolant will gush out of the coolant tank and severely scald any persons in the general area of the generator.



### CAUTION

- **NEVER** touch the hot exhaust manifold, muffler or cylinder. Allow these parts to cool before servicing equipment.



## NOTICE

- **NEVER** run engine without an air filter or with a dirty air filter. Severe engine damage may occur. Service air filter frequently to prevent engine malfunction.
- **NEVER** tamper with the factory settings of the engine or engine governor. Damage to the engine or equipment can result if operating in speed ranges above the maximum allowable.
- Wet stacking is a common problem with diesel engines which are operated for extended periods with light or no load applied. When a diesel engine operates without sufficient load (less than 40% of the rated output), it will not operate at its optimum temperature. This will allow unburned fuel to accumulate in the exhaust system, which can foul the fuel injectors, engine valves and exhaust system, including turbochargers, and reduce the operating performance.



In order for a diesel engine to operate at peak efficiency, it must be able to provide fuel and air in the proper ratio and at a high enough engine temperature for the engine to completely burn all of the fuel.

Wet stacking does not usually cause any permanent damage and can be alleviated if additional load is applied to relieve the condition. It can reduce the system performance and increase maintenance. Applying an increasing load over a period of time until the excess fuel is burned off and the system capacity is reached usually can repair the condition. This can take several hours to burn off the accumulated unburned fuel.

- State Health Safety Codes and Public Resources Codes specify that in certain locations, spark arresters must be used on internal combustion engines that use hydrocarbon fuels. A spark arrester is a device designed to prevent accidental discharge of sparks or flames from the engine exhaust. Spark arresters are qualified and rated by the United States Forest Service for this purpose. In order to comply with local laws regarding spark arresters, consult the engine distributor or the local Health and Safety Administrator.

# SAFETY INFORMATION

## FUEL SAFETY

### DANGER

- **DO NOT** start the engine near spilled fuel or combustible fluids. Diesel fuel is extremely flammable and its vapors can cause an explosion if ignited.
- **ALWAYS** refuel in a well-ventilated area, away from sparks and open flames.
- **ALWAYS** use extreme caution when working with **flammable** liquids.
- **DO NOT** fill the fuel tank while the engine is running or hot.
- **DO NOT** overfill tank, since spilled fuel could ignite if it comes into contact with hot engine parts or sparks from the ignition system.
- Store fuel in appropriate containers, in well-ventilated areas and away from sparks and flames.
- **NEVER** use fuel as a cleaning agent.
- **DO NOT** smoke around or near the equipment. Fire or explosion could result from fuel vapors or if fuel is spilled on a hot engine.



## TOWING SAFETY

### CAUTION

- Check with your local county or state safety towing regulations, in addition to meeting **Department of Transportation (DOT) Safety Towing Regulations**, before towing your generator.
- Refer to MQ Power trailer manual for additional safety information.
- In order to reduce the possibility of an accident while transporting the generator on public roads, **ALWAYS** make sure the trailer that supports the generator and the towing vehicle are mechanically sound and in good operating condition.
- **ALWAYS** shutdown engine before transporting



- Make sure the hitch and coupling of the towing vehicle are rated equal to, or greater than the trailer “gross vehicle weight rating.”
- **ALWAYS** inspect the hitch and coupling for wear. **NEVER** tow a trailer with defective hitches, couplings, chains, etc.
- Check the tire air pressure on both towing vehicle and trailer. **Trailer tires should be inflated to 50 psi cold.** Also check the tire tread wear on both vehicles.
- **ALWAYS** make sure the trailer is equipped with a **safety chain**.
- **ALWAYS** properly attach trailer’s safety chains to towing vehicle.
- **ALWAYS** make sure the vehicle and trailer directional, backup, brake and trailer lights are connected and working properly.
- DOT Requirements include the following:
  - Connect and test electric brake operation.
  - Secure portable power cables in cable tray with tie wraps.
- The maximum speed for highway towing is **55 MPH** unless posted otherwise. Recommended off-road towing is not to exceed **15 MPH** or less depending on type of terrain.
- Avoid sudden stops and starts. This can cause skidding, or jack-knifing. Smooth, gradual starts and stops will improve towing.
- Avoid sharp turns to prevent rolling.
- Trailer should be adjusted to a level position at all times when towing.
- Raise and lock trailer wheel stand in up position when towing.
- Place **chock blocks** underneath wheel to prevent **rolling** while parked.
- Place **support blocks** underneath the trailer’s bumper to prevent **tipping** while parked.
- Use the trailer’s swivel jack to adjust the trailer height to a level position while parked.

# SAFETY INFORMATION

## ELECTRICAL SAFETY

### DANGER

- **DO NOT** touch output terminals during operation. Contact with output terminals during operation can cause **electrocution, electrical shock or burn.**



- The electrical voltage required to operate the generator can cause severe injury or even death through physical contact with live circuits. Turn generator and all circuit breakers **OFF** before performing maintenance on the generator or making contact with output terminals.

- **NEVER** insert any objects into the output receptacles during operation. This is extremely dangerous. The possibility exists of **electrical shock, electrocution or death.**



- Backfeed to a utility system can cause **electrocution** and/or property damage. **NEVER** connect the generator to a building's electrical system without a transfer switch or other approved device. All installations should be performed by a **licensed electrician** in accordance with all applicable laws and electrical codes. Failure to do so could result in electrical shock or burn, causing **serious injury or even death.**



## Power Cord/Cable Safety

### DANGER

- **NEVER** let power cords or cables **lay in water.**
- **NEVER stand in water** while AC power from the generator is being transferred to a load.
- **NEVER** use **damaged** or **worn** cables or cords when connecting equipment to generator. Inspect for cuts in the insulation.
- **NEVER** grab or touch a live power cord or cable with wet hands. The possibility exists of **electrical shock, electrocution or death.**

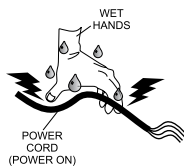

- Make sure power cables are securely connected to the generator's output receptacles. Incorrect connections may cause electrical shock and damage to the generator.

### NOTICE

- **ALWAYS** make certain that proper power or extension cord has been selected for the job. See Cable Selection Chart in this manual.

## Grounding Safety

### DANGER

- **ALWAYS** make sure that electrical circuits are properly grounded to a suitable earth ground (ground rod) per the National Electrical Code (NEC) and local codes before operating generator. **Severe injury or death by electrocution** can result from operating an ungrounded generator.

- **NEVER** use gas piping as an electrical ground.

## BATTERY SAFETY

### DANGER

- **DO NOT** drop the battery. There is a possibility that the battery will explode.
- **DO NOT** expose the battery to open flames, sparks, cigarettes, etc. The battery contains combustible gases and liquids. If these gases and liquids come into contact with a flame or spark, an explosion could occur.



### WARNING

- **ALWAYS** wear safety glasses when handling the battery to avoid eye irritation. The battery contains acids that can cause injury to the eyes and skin.
- Use well-insulated gloves when picking up the battery.
- **ALWAYS** keep the battery charged. If the battery is not charged, combustible gas will build up.
- **ALWAYS** recharge the battery in a well-ventilated environment to avoid the risk of a dangerous concentration of combustible gasses.





# SAFETY INFORMATION

- If the battery liquid (dilute sulfuric acid) comes into contact with **clothing or skin**, rinse skin or clothing immediately with plenty of water.
- If the battery liquid (dilute sulfuric acid) comes into contact with **eyes**, rinse eyes immediately with plenty of water and contact the nearest doctor or hospital to seek medical attention.

## CAUTION

- **ALWAYS** disconnect the **NEGATIVE battery terminal** before performing service on the generator.
- **ALWAYS** keep battery cables in good working condition. Repair or replace all worn cables.

## ENVIRONMENTAL SAFETY/DECOMMISSIONING

### NOTICE

Decommissioning is a controlled process used to safely retire a piece of equipment that is no longer serviceable. If the equipment poses an unacceptable and unreparable safety risk due to wear or damage or is no longer cost effective to maintain (beyond life-cycle reliability) and is to be decommissioned (demolition and dismantlement), be sure to follow rules below.

- **DO NOT** pour waste or oil directly onto the ground, down a drain or into any water source.
- Contact your country's Department of Public Works or recycling agency in your area and arrange for proper disposal of any electrical components, waste or oil associated with this equipment.
- When the life cycle of this equipment is over, remove battery and bring to appropriate facility for lead reclamation. Use safety precautions when handling batteries that contain sulfuric acid.
- When the life cycle of this equipment is over, it is recommended that the trowel frame and all other metal parts be sent to a recycling center.



Metal recycling involves the collection of metal from discarded products and its transformation into raw materials to use in manufacturing a new product.

Recyclers and manufacturers alike promote the process of recycling metal. Using a metal recycling center promotes energy cost savings.

## EMISSIONS INFORMATION

### NOTICE

The diesel engine used in this equipment has been designed to reduce harmful levels of carbon monoxide (CO), hydrocarbons (HC) and nitrogen oxides (NOx) contained in diesel exhaust emissions.

This engine has been certified to meet US EPA Evaporative emissions requirements in the installed configuration.

Attempting to modify or make adjustments to the engine emission system by unauthorized personnel without proper training could damage the equipment or create an unsafe condition.

Additionally, modifying the fuel system may adversely affect evaporative emissions, resulting in fines or other penalties.

### Emission Control Label

The emission control label is an integral part of the emission system and is strictly controlled by regulations.

The label must remain with the engine for its entire life.

If a replacement emission label is needed, please contact your authorized engine distributor.

# SPECIFICATIONS

**Table 1. Generator Specifications**

<b>Model</b>	MQP240
<b>Type</b>	Revolving field, self ventilated, open protected type synchronous generator
<b>Armature Connection</b>	<b>Star with Neutral</b>
<b>Phase</b>	3
<b>Standby Output</b>	260 KW
<b>Prime Output</b>	240 KW
<b>3Ø Voltage (L-L/L-N) Voltage Change-Over Bd. at 3Ø 240/139</b>	208Y/120, 220Y/127, 240Y/139
<b>3Ø Voltage (L-L/L-N) Voltage Change-Over Bd. at 3Ø 480/277</b>	416Y/240, 440Y/254, 480Y/277
<b>Power Factor</b>	0.8
<b>Frequency</b>	60 Hz
<b>Speed</b>	1800 rpm
<b>Aux. AC Power</b>	Single Phase, 60 Hz
<b>Aux. Voltage/Output</b>	4.8 Kw (2.4 kW x 2)
<b>Dry Weight</b>	8,811 lbs. (4,000 kg)
<b>Wet Weight</b>	9,010lbs. (4,091 kg)

**Table 2. Engine Specifications**

<b>Model</b>	Cummins QSL9-G3 Tier 3	
<b>Type</b>	4 cycle, water-cooled, direct injection, turbo-charged with air to air after-cooler	
<b>No. of Cylinders</b>	6 cylinders	
<b>Bore x Stroke</b>	4.49 in. x 5.69 in. (114 mm x 145 mm)	
<b>Displacement</b>	543 cu. in. (8900 cc)	
<b>Rated Output</b>	363 HP at 1800 rpm	
<b>Starting</b>	Electric	
<b>Coolant Capacity</b>	11.3 gal. (43.0 liters)	
<b>Lube Oil Capacity</b>	7.0 gal. (26.5 liters)	
<b>Fuel Type</b>	#2 Diesel Fuel	
<b>Fuel Consumption</b>	19.0 gal. (72.0 L)/hr at <b>full load</b>	15.5 gal. (58.6 L)/hr at <b>3/4 load</b>
	11.1 gal. (41.9 L)/hr at <b>1/2 load</b>	5.9 gal. (22.4 L)/hr at <b>1/4 load</b>
<b>Battery</b>	150 Ah x 2 (24V System)	

# DIMENSIONS

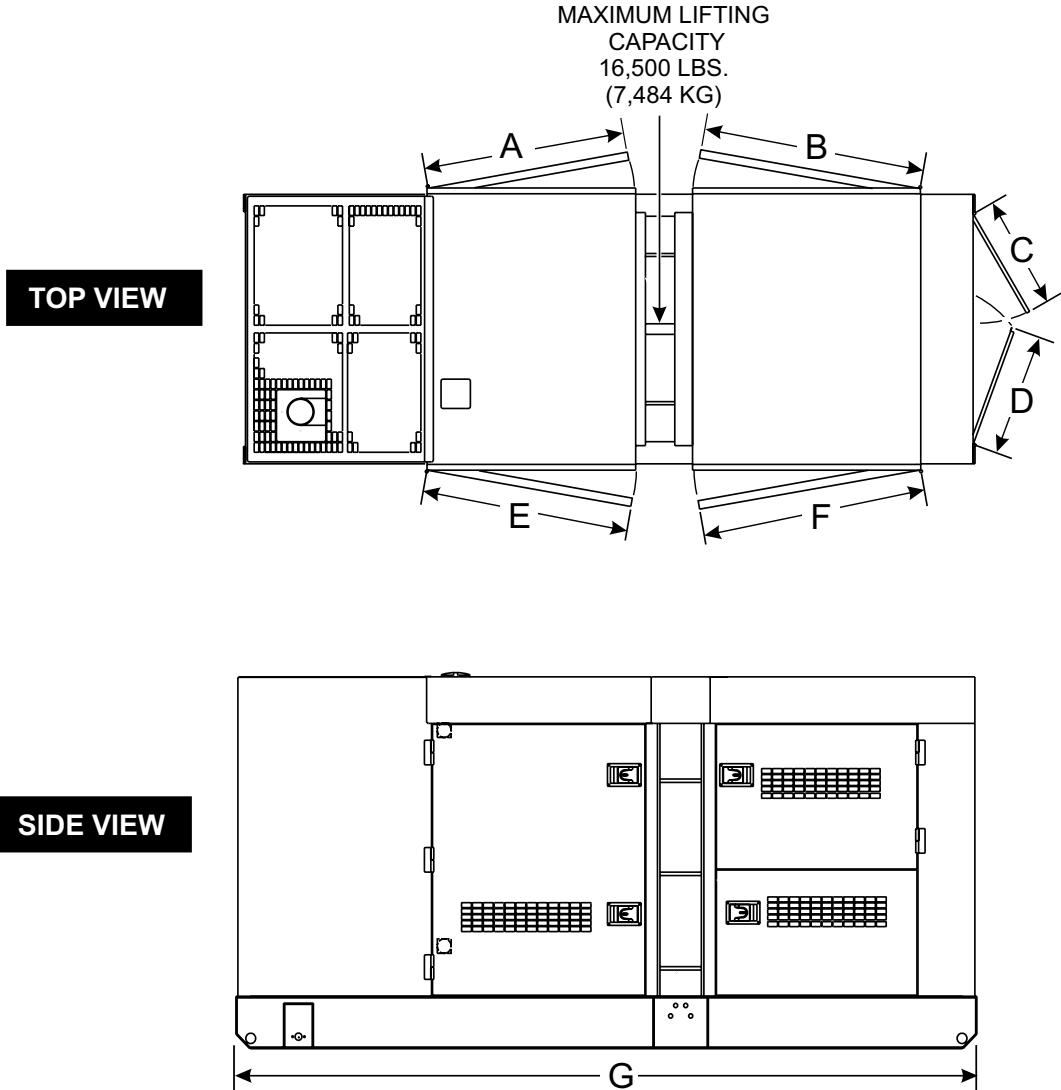

Figure 1. Dimensions

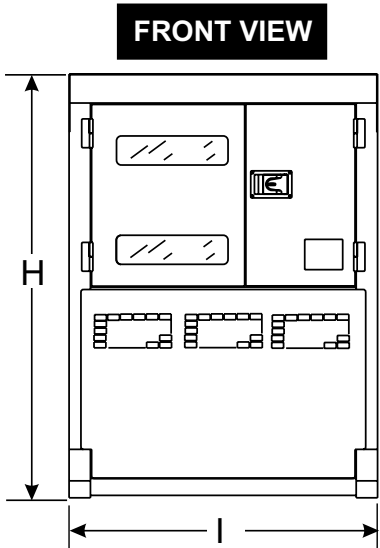

Table 3. Dimensions			
Reference Letter	Dimension in. (mm)	Reference Letter	Dimension in. (mm)
A	39.76 in. (1,010 mm)	F	43.90 in. (1,115 mm)
B	43.90 in. (1,115 mm)	G	149.61 in. (3,800 mm)
C	23.03 in. (585 mm.)	H	70.87 in. (1,800 mm)
D	25.20 in. (640 mm)	I	55.12 in. (1,400 mm)
E	39.76 in. (1,010 mm)		

# INSTALLATION

## CONNECTING THE GROUND

Consult with local Electrical and Safety Codes for proper connection based on condition of use.

### EXAMPLE of how to ground the unit if the condition of use requires such a device:

The ground terminal on the generator should always be used to connect the generator to a suitable ground when required.

The ground cable should be #8 size wire (aluminum) minimum. If copper wire is used, #10 size wire minimum should be used.

Connect one end of the ground cable terminal to the generator ground point (Figure 2). Connect the other end of the ground cable to a suitable earth ground (ground rod).

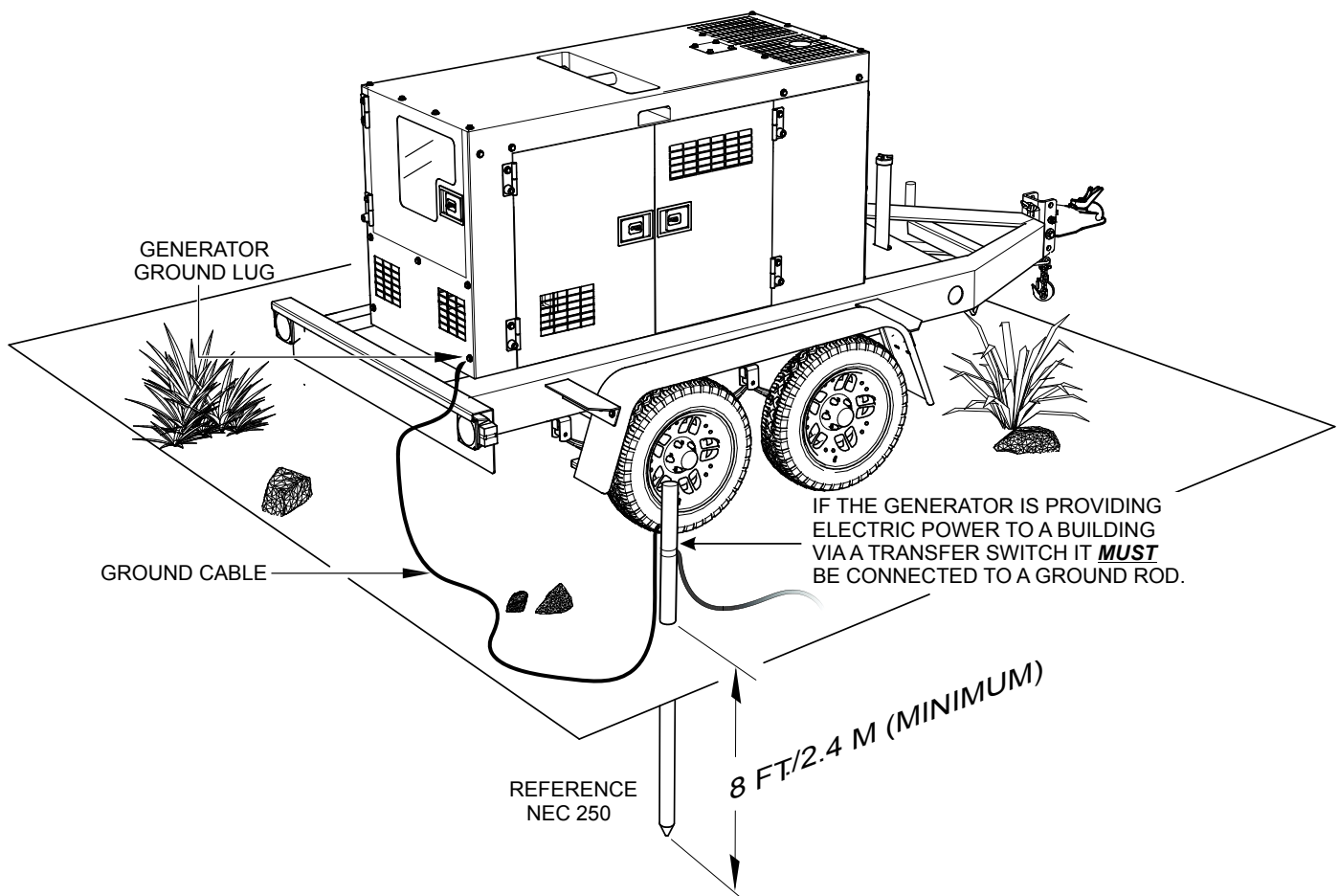

Figure 2. Typical Generator Grounding Application

## OUTDOOR INSTALLATION

Install the generator in a area that is free of debris, bystanders, and overhead obstructions. Make sure the generator is on secure level ground so that it cannot slide or shift around. Also install the generator in a manner so that the exhaust will not be discharged in the direction of nearby homes.

The installation site must be relatively free from moisture and dust. All electrical equipment should be protected from excessive moisture. Failure to do will result in deterioration of the insulation and will result in short circuits and grounding.

Foreign materials such as dust, sand, lint and abrasive materials have a tendency to cause excessive wear to engine and alternator parts.

### CAUTION

Pay close attention to ventilation when operating the generator inside tunnels and caves. The engine exhaust contains noxious elements. Engine exhaust must be routed to a ventilated area.

## INDOOR INSTALLATION

Exhaust gases from diesel engines are extremely poisonous. Whenever an engine is installed indoors the exhaust fumes must be vented to the outside. The engine should be installed at least two feet from any outside wall. Using an exhaust pipe which is too long or too small can cause excessive back pressure which will cause the engine to heat excessively and possibly burn the valves.

## MOUNTING

The generator must be mounted on a solid foundation such as concrete) and set firmly on the foundation to isolate vibration of the generator when it is running. The generator must set at least 6 inches above the floor or grade level (in accordance to NFPA 110, Chapter 54.1). **DO NOT** remove the metal skids on the bottom of the generator. They are to resist damage to the bottom of the generator and to maintain alignment.

## GENERATOR GROUNDING

### NOTICE

The Occupational Safety and Health Administration (OSHA) and the National Electrical Code (NEC) recommend that if the generator is providing electrical power to a structure (home, office shop, trailer or similar) it **must** be connected to a grounding electrode system, such as driven ground rod (Figure 2).

If applicable, to guard against electrical shock and possible damage to the equipment, it is important to provide a good **EARTH** ground, (Figure 2).

### NOTICE

**ALWAYS** check with State, Province, District and Municipalities for electrical grounding requirements before using generator.

Article 250 (Grounding) of the NEC handbook provides guidelines for proper grounding and specifies that the cable ground shall be connected to the grounding system of the building as close to the point of cable entry as practical.

NEC article 250 specifies the following grounding requirements:

1. Use one of the following wire types to connect the generator to earth ground.
  - a. Copper 10 AWG (5.3 mm<sup>2</sup>) or larger.
  - b. Aluminum 8 AWG (8.4 mm<sup>2</sup>) or larger.
2. When grounding of the generator (Figure 2) is required, connect one end of the ground cable to the ground lug on the generator. Connect the other end of the ground cable to the ground rod (earth ground).
3. NEC article 250 specifies that the earth ground rod should be buried a minimum of 8 ft. into the ground.

### NOTICE

When connecting the generator to any buildings electrical system **ALWAYS** consult with a licensed electrician.

# GENERAL INFORMATION

## GENERATOR

The MQP240 generator (Figure 3) is designed as a high quality portable (requires a trailer for transport) power source for telecom sites, lighting facilities, power tools, submersible pumps and other industrial and construction machinery.

## ENGINE OPERATING PANEL

The “Engine Operating Panel” is provided with the following:

- Tachometer
- Emergency Stop Switch
- Water Temperature Gauge
- Oil Pressure Gauge
- Charging Ammeter Gauge
- Fuel Level Gauge
- Engine Speed Switch
- Battery Switch
- Engine Alarm Lamps (4)

## GENERATOR CONTROL PANEL

The “Generator Control Panel” is provided with the following:

- Frequency Meter (Hz)
- AC Ammeter (Amps)
- AC Voltmeter (Volts)
- Ammeter Change-Over Switch
- Voltmeter Change-Over Switch
- Voltage Regulator
- Panel Light/Panel Light Switch
- 3-Pole, 800 amp Main Circuit Breaker
- “Control Box” (located behind the Gen. Control Panel)
  - Automatic Voltage Regulator
  - Current Transformer
  - Over-Current Relay
  - Starter Relay
  - Engine Controller (Computer Controlled)

## OUTPUT TERMINAL PANEL

The “Output Terminal Panel” is provided with the following:

- Three 120/240V output receptacles (CS-6369), 50A
- Three auxiliary circuit breakers, 50A
- Two 120V output receptacles (GFCI), 20A
- Two GFCI circuit breakers, 20A
- Eight output terminal lugs (3Ø power)
- Battery Charger (Optional)
- Water Heater (Optional)

## OPEN DELTA EXCITATION SYSTEM

Each generator is equipped with the state of the art “Open-Delta” excitation system. The open delta system consist of an electrically independent winding wound among stationary windings of the AC output section.

There are four connections of the open delta A, B, C and D. During steady state loads, the power from the voltage regulator is supplied from the parallel connections of A to B, A to D, and C to D. These three phases of the voltage input to the voltage regulator are then rectified and are the excitation current for the exciter section.

When a heavy load, such as a motor starting or a short circuit occurs, the automatic voltage regulator (AVR) switches the configuration of the open delta to the series connection of B to C. This has the effect of adding the voltages of each phase to provide higher excitation to the exciter section and thus better voltage response during the application of heavy loads.

The connections of the AVR to the AC output windings are for sensing only. No power is required from these windings. The open-delta design provides virtually unlimited excitation current, offering maximum motor starting capabilities. The excitation does not have a “fixed ceiling” and responds according the demands of the required load.

## ENGINE

Both generators are powered by a 6 cylinder, 4-cycle water cooled, direct injection, turbocharged, charge air cooled Cummins QSL9-G3 diesel engine. This engine is designed to meet every performance requirement for the generator. Reference Table 2 for engine specifications.

In keeping with MQ Power’s policy of constantly improving its products, the specifications quoted herein are subject to change without prior notice.

## ELECTRIC GOVERNOR SYSTEM

The electric governor system controls the RPMs of the engine. When the engine demand increases or decreases, the governor system regulates the frequency variation to  $\pm 0.25\%$ .

## EXTENSION CABLES

When electric power is to be provided to various tools or loads at some distance from the generator, extension cords are normally used. Cables should be sized to allow for distance in length and amperage so that the voltage drop between the generator and point of use (load) is held to a minimum. Use the cable selection chart (Table 6) as a guide for selecting proper extension cable size.

# MAJOR COMPONENTS

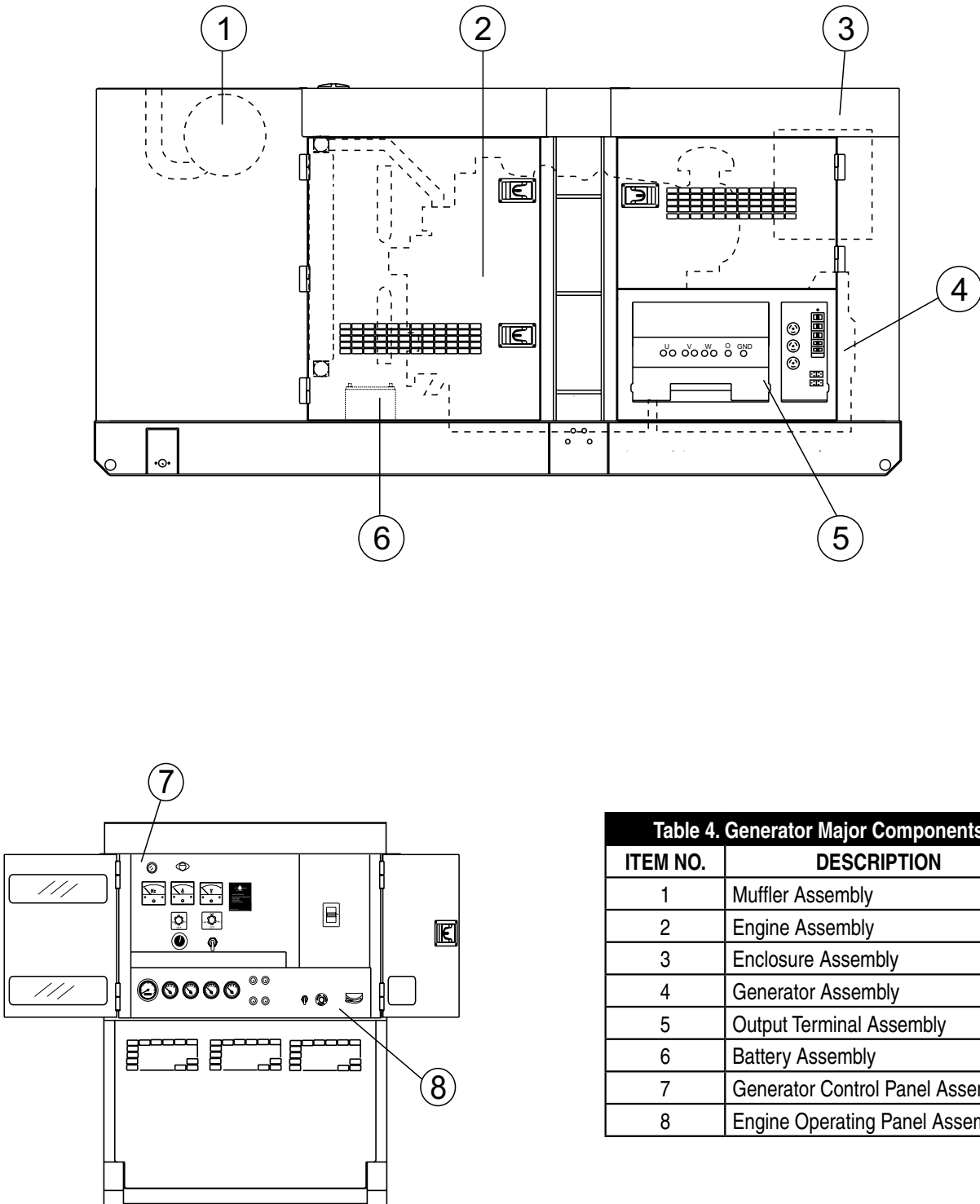

Table 4. Generator Major Components	
ITEM NO.	DESCRIPTION
1	Muffler Assembly
2	Engine Assembly
3	Enclosure Assembly
4	Generator Assembly
5	Output Terminal Assembly
6	Battery Assembly
7	Generator Control Panel Assembly
8	Engine Operating Panel Assembly

Figure 3. Major Components

# GENERATOR CONTROL PANEL

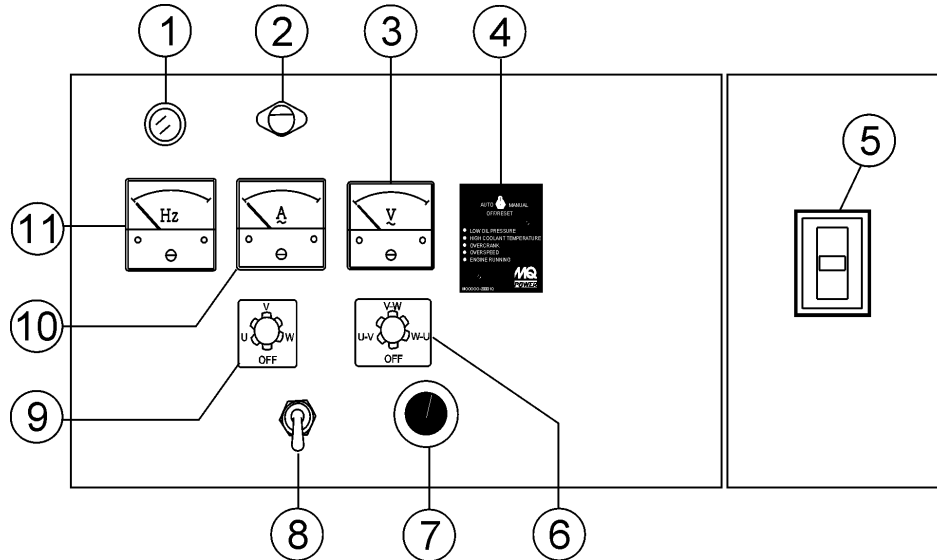
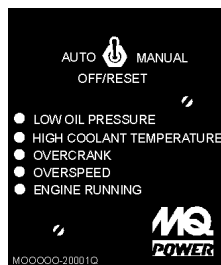

Figure 4. Generator Control Panel

The definitions below describe the controls and functions of the Generator Control Panel (Figure 4).

1. **Pilot Lamp** — Indicates the system is running.
2. **Panel Light** — Normally used in dark areas or at night time. When activated, panel lights will illuminate. When the generator is not in use be sure to turn the panel light switch to the **OFF** position.
3. **AC Voltmeter** — Indicates the output voltage present at the **U,V, and W Output Terminal Lugs**.
4. **Auto On/Off Engine Controller (MPEC)** —

This controller has a vertical row of status LED's (inset), that when lit, indicate that an engine malfunction (fault) has been detected. When a fault has been detected the engine controller will evaluate the fault and all major faults will shutdown the generator. During **cranking cycle**, The MPEC will attempt to crank the engine for 10 seconds before disengaging.



If the engine does not engage (start) by the third attempt, the engine will be shutdown by the engine controller's **Over Crank Protection** mode. If the engine engages at a speed (RPM's) that is not safe,

the controller will shutdown the engine by initializing the **Over Speed Protection** mode.

5. **Main Circuit Breaker** — This three-pole, 800 amp main breaker is provided to protect the **U,V, and W Output Terminal Lugs** from overload.
6. **Voltmeter Change-Over Switch** — This switch allows the AC voltmeter to indicate phase to phase voltage between any two phases of the output terminals or to be switched off.
7. **Voltage Regulator Control** — Allows  $\pm 15\%$  manual adjustment of the generator's output voltage.
8. **Panel Light Switch** — When activated will turn on control panel light.
9. **Ammeter Change-Over Switch** — This switch allows the AC ammeter to indicate the current flowing to the load connected to any phase of the output terminals, or to be switched off. This switch does not effect the generator output in any fashion, it is for current reading only.
10. **AC Ammeter** — Indicates the amount of current the load is drawing from the generator per leg selected by the ammeter phase-selector switch.
11. **Frequency Meter** — Indicates the output frequency in hertz (Hz). Normally 60 Hz.



# GENERATOR CONTROL PANEL

■ **MPEC Control Switch** — This switch controls the running of the unit. If this switch is set to the **OFF/RESET** position, the unit will not run. When this switch is set to the manual position, the generator will start immediately.

If the generator is to be connected to a building's AC power source via a transfer switch (isolation), place the switch in the AUTO position. In this position, should an outage occur, the automatic transfer switch (ATS) will start the generator automatically via the generator's auto-start contacts connected to the ATS's start contacts. Please refer to your ATS installation manual for further instructions for the correct installation of the auto-start contacts of the generator to the ATS.

■ **Low Oil Pressure** — Indicates the engine pressure has fallen below a safe operating level. The oil pressure is detected using variable resistive values from the oil pressure sending unit. This is considered a **major** fault.

■ **High Coolant Temperature** — Indicates the engine temperature has exceeded a safe operating level. The engine temperature is detected using variable resistive values from the temperature sending unit. This is considered a **major** fault.

■ **Overcrank Shutdown** — Indicates the unit has attempted to start a pre-programmed number of times and has failed to start. The number of cycles and duration are programmable. It is pre-set at 3 cycles with a 10-second duration. This is considered a **major** fault.

■ **Overspeed Shutdown** — Indicates the engine is running at an unsafe speed. This is considered a **major** fault.

■ **Engine Running** — Indicates that engine is running at a safe operating speed.

Located behind the generator control panel is the **Generator Control Box**. This box contains some of the necessary electronic components required to make the generator function.

The **Control Box** is equipped with the following major components:

- Over-Current Relay
- Voltage Rectifier (AVR)
- Starter Relay
- Current Transformer
- Voltage Change-Over Board
- Three Phase Circuit Breaker

## NOTICE

Remember the **overcurrent relay** monitors the current flowing from the **U,V, and W Output Terminal Lugs** to the load.

In the event of a short circuit or over current condition, it will automatically trip the 800 amp main breaker.

To restore power to the **Output Terminal Panel**, press the reset button on the overcurrent relay and place the **main** circuit breaker in the **closed** position (**ON**).

# ENGINE OPERATING PANEL

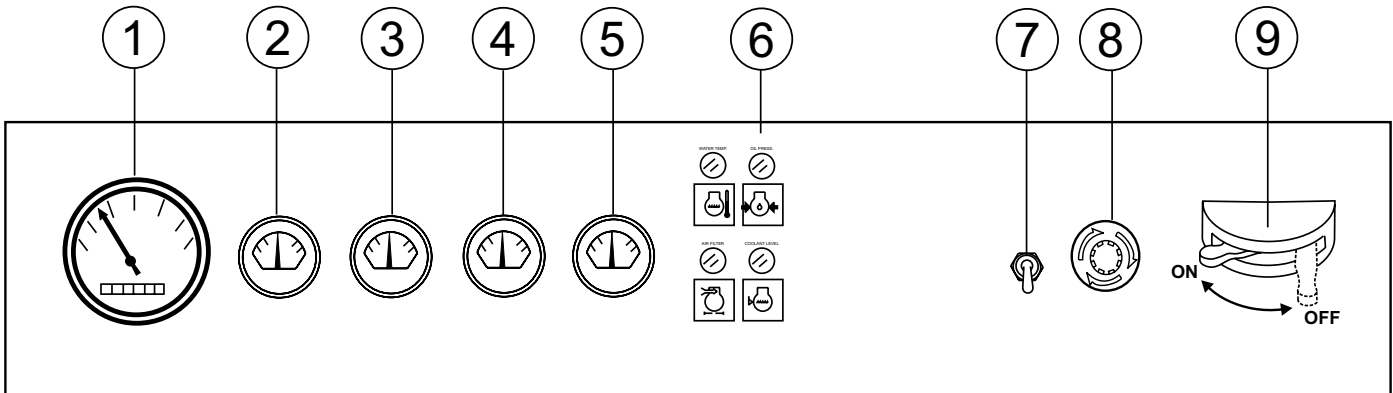

Figure 5. Engine Operating Panel

The definitions below describe the controls and functions of the Engine Operating Panel (Figure 5).

1. **Tachometer** — Indicates engine speed in RPM's for 60 Hz operation. This meter should indicate 1800 RPM's when the rated load is applied. In addition a built in hour meter will record the number of operational hours that the generator has been in use.
2. **Oil Pressure Gauge** — During normal operation this gauge should read between 28 to 85 psi. (193~586 kPa). When starting the generator the oil pressure may read a little higher, but after the engine warms up the oil pressure should return to the correct pressure range.
3. **Water Temperature Gauge** — During normal operation this gauge should read between 167° and 203°F (75°~95°C).
4. **Charging Ammeter Gauge** — Indicates the current being supplied by the engine's alternator which provides current for generator's control circuits and battery charging system.
5. **Fuel Gauge** — Indicates amount of diesel fuel available.
6. **Engine Warning Lamps** — There are four engine warning lamps, they are defined as follows:

- a. **Overheat Lamp** — This lamp goes **ON** when the cooling water temperature rises abnormally. If the lamp goes **ON** during normal operation of the generator, the emergency shutdown device will stop the engine automatically.



- b. **Low Oil Pressure Lamp** — During normal operation of the generator this lamp should remain **OFF**. When the

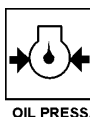

**Auto-OFF/Reset-Manual** switch is set to the **MANUAL** position to start the engine, the lamp will be lit. When the oil pressure rises after start-up the lamp will go **OFF**. If this lamp is ever lit (**ON**) during normal operation of the generator, the emergency shutdown device will stop the engine automatically.

- c. **Air Filter Alarm** — When the air filter element is clogged, this lamp goes **ON** indicating the element should be immediately cleaned or replaced.
- d. **Coolant Level Alarm** — This lamp goes **ON** when the coolant level is low. If this lamp goes **ON** while the engine is in operation, the emergency shutdown device will automatically stop the engine.



7. **Engine Speed Switch** — This switch controls the speed of the engine (low/high).
8. **Emergency Stop Button** — Push this button inward to stop the engine in the event of an emergency. **DO NOT** use this button as a means of stopping the engine.
9. **Battery Switch** — This switch should be set to the **ON** position during normal operation. When the engine has been stopped, place this switch in the **OFF** position. **DO NOT** turn this switch during normal operation, it could cause damage to the electrical equipment.



# OUTPUT TERMINAL PANEL FAMILIARIZATION

## OUTPUT TERMINAL PANEL

The Output Terminal Panel (Figure 6) shown below is located on the right-hand side (left from control panel) of the generator. Lift up on the cover to gain access to receptacles and terminal lugs.

### NOTICE

Terminal legs "O" and "Ground" are considered bonded grounds.

## OUTPUT TERMINAL FAMILIARIZATION

The "Output Terminal Panel" (Figure 6) is provided with the following:

- Three (3) 240/139V output receptacles @ 50 amps
- Three (3) Circuit Breakers @ 50 amps
- Two (2) 120V GFCI receptacles @ 20 amps
- Two (2) GFCI Circuit Breakers @ 20 amps
- Eight (8) Output Terminal Lugs ( U, V, W, O, Ground)

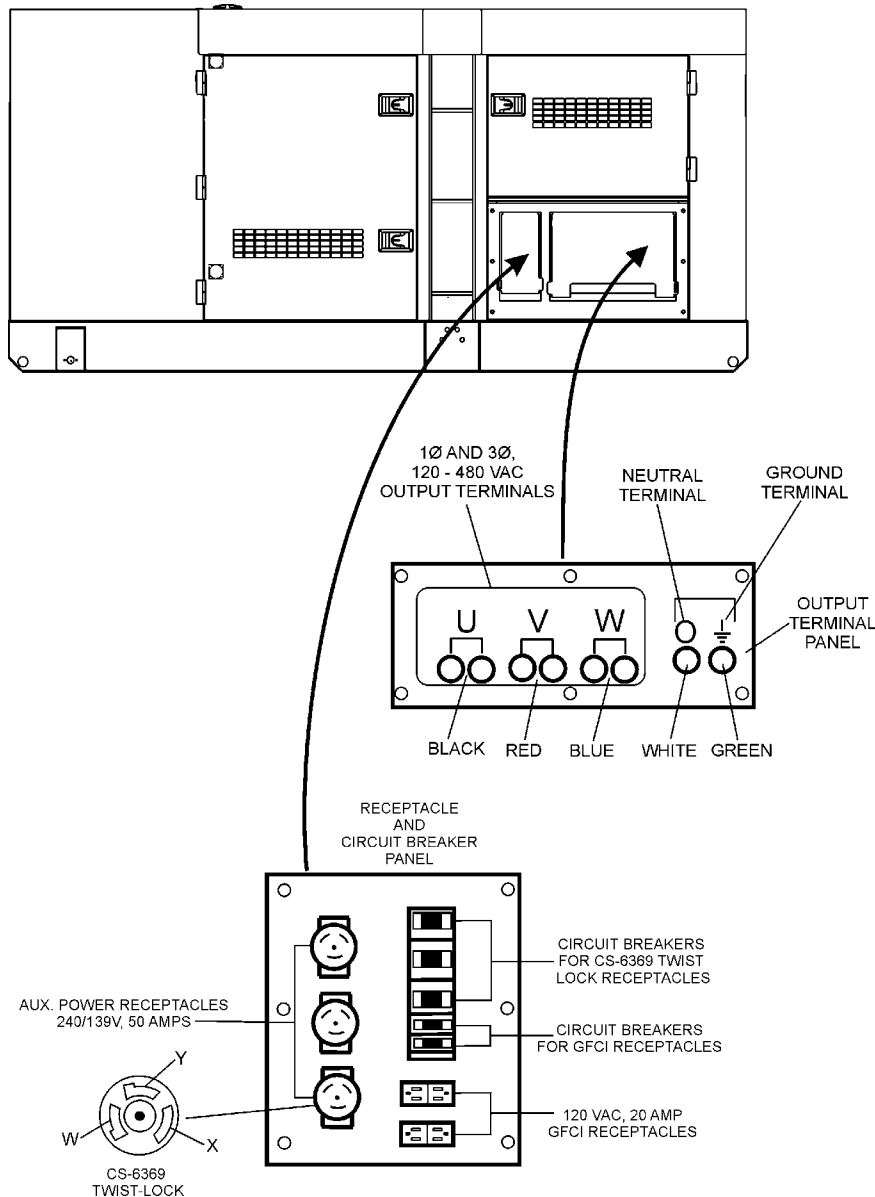

Figure 6. Output Terminal Panel

# OUTPUT TERMINAL PANEL FAMILIARIZATION

## 120 VAC GFCI Receptacles

There are two 120 VAC, 20 amp GFCI (Duplex Nema 5-20R) receptacles provided on the output terminal panel. These receptacles can be accessed in any **voltage change-over board** configuration. Each receptacle is protected by a 20 amp circuit breaker. These breakers are located directly above the GFCI receptacles. Remember the load output (current) of both GFCI receptacles is dependent on the load requirements of the U, V, and W output terminal lugs.

Pressing the **reset** button resets the GFCI receptacle after being tripped. Pressing the **test button** (See Figure 7) in the center of the receptacle will check the GFCI function. Both receptacles should be tested at least once a month.

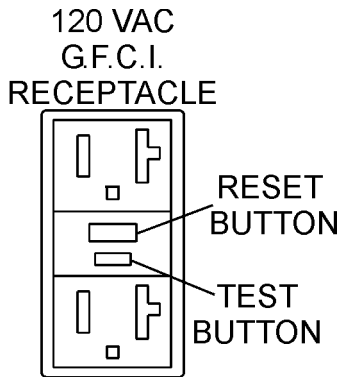

Figure 7. G.F.C.I. Receptacle

## Twist Lock Dual Voltage 120/240 VAC Receptacles

There are three 120/240V, 50 amp auxiliary twist-lock (CS-6369) receptacles (Figure 8) provided on the output terminal panel. These receptacles can **only** be accessed when the voltage change-over board is configured for **single-phase 240/120** application

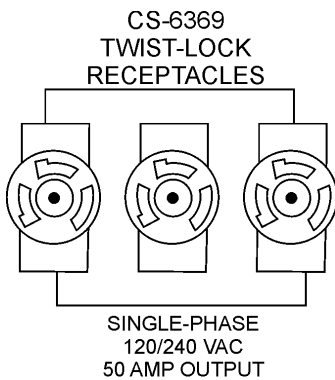

Figure 8. 120/240V Twist-Lock Auxiliary Receptacles

Each auxiliary receptacle is protected by a 50 amp circuit breaker. These breakers are located directly above the GFCI receptacles. Remember the load output (current) on all three receptacles is dependent on the load requirements of the **output terminal lugs**.

Turn the **voltage regulator control knob** (Figure 9) on the control panel to obtain the desired voltage. Turning the knob clockwise will **increase** the voltage, turning the knob counter-clockwise will **decrease** the voltage.

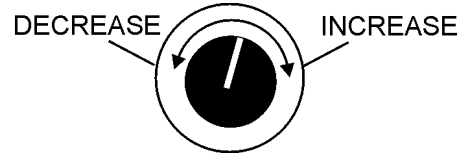

Figure 9. Voltage Regulator Control Knob

# OUTPUT TERMINAL PANEL FAMILIARIZATION

## Connecting Loads

Loads can be connected to the generator by the **Output Terminal Lugs** or the convenience receptacles (Figure 10). Make sure to read the operation manual before attempting to connect a load to the generator.

To protect the output terminals from overload, a 3-pole, 800A **main** circuit breaker is provided. Make sure to switch **ALL** circuit breakers to the **OFF** position prior to starting the engine.

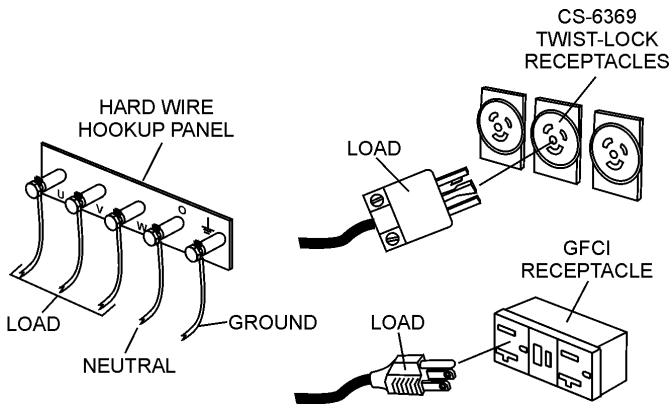

Figure 10. Connecting Loads

## Over Current Relay

An **over current relay** (Figure 11) is connected to the main circuit breaker. In the event of an overload, both the circuit breaker and the over current relay may trip. If the circuit breaker can not be reset, the **reset button** on the over current relay must be pressed. The over current relay is located in the control box.

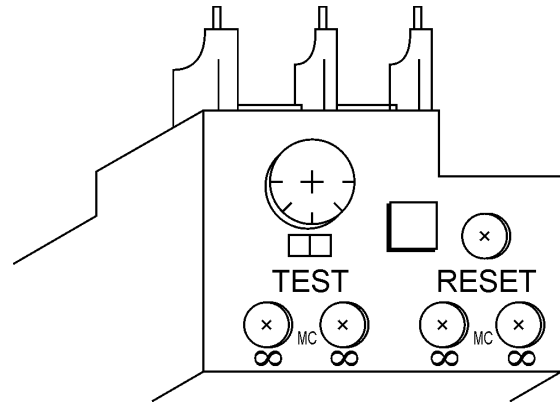

Figure 11. Over Current Relay

# LOAD APPLICATION

## SINGLE PHASE LOAD

Always be sure to check the nameplate on the generator and equipment to insure the wattage, amperage, frequency, and voltage requirements are satisfactorily supplied by the generator for operating the equipment.

Generally, the wattage listed on the nameplate of the equipment is its rated output. Equipment may require 130—150% more wattage than the rating on the nameplate, as the wattage is influenced by the efficiency, power factor and starting system of the equipment.

### NOTICE

If wattage is not given on the equipment's name plate, approximate wattage may be determined by multiplying nameplate voltage by the nameplate amperage.

$$\text{WATTS} = \text{VOLTAGE} \times \text{AMPERAGE}$$

The power factor of this generator is 0.8. See Table 5 below when connecting loads.

**Table 5. Power Factor By Load**

Type of Load	Power Factor
Single-phase induction motors	0.4-0.75
Electric heaters, incandescent lamps	1.0
Fluorescent lamps, mercury lamps	0.4-0.9
Electronic devices, communication equipment	1.0
Common power tools	0.8

**Table 6. Cable Selection (60 Hz, Single Phase Operation)**

Current in Amperes	Load in Watts		Maximum Allowable Cable Length			
	At 100 Volts	At 200 Volts	#10 Wire	#12 Wire	#14 Wire	#16 Wire
2.5	300	600	1000 ft.	600 ft.	375 ft.	250 ft.
5	600	1200	500 ft.	300 ft.	200 ft.	125 ft.
7.5	900	1800	350 ft.	200 ft.	125 ft.	100 ft.
10	1200	2400	250 ft.	150 ft.	100 ft.	
15	1800	3600	150 ft.	100 ft.	65 ft.	
20	2400	4800	125 ft.	75 ft.	50 ft.	

CAUTION: Equipment damage can result from low voltage

## THREE PHASE LOAD

When calculating the power requirements for 3-phase power use the following equation:

$$\text{KVA} = \frac{\text{VOLTAGE} \times \text{AMPERAGE} \times 1.732}{1000}$$

### NOTICE

If 3Ø load (kVA) is not given on the equipment nameplate, approximate 3Ø load may be determined by multiplying voltage by amperage by 1.732.

### NOTICE

Motors and motor-driven equipment draw much greater current for starting than during operation.

An inadequate size connecting cable which cannot carry the required load can cause a voltage drop which can burn out the appliance or tool and overheat the cable. See Table 6.

- When connecting a resistance load such as an incandescent lamp or electric heater, a capacity of up to the generating set's rated output (kW) can be used.
- When connecting a fluorescent or mercury lamp, a capacity of up to the generating set's rated output (kW) multiplied by 0.6 can be used.
- When connecting an electric drill or other power tools, pay close attention to the required starting current capacity.

When connecting ordinary power tools, a capacity of up to the generating set's rated output (kW) multiplied by 0.8 can be used.

### DANGER

Before connecting this generator to any building's electrical system, a **licensed electrician** must install an **isolation (transfer) switch**. Serious damage to the building's electrical system may occur without this transfer switch.

# GENERATOR OUTPUTS

## GENERATOR OUTPUT VOLTAGES

A wide range of voltages are available to supply voltage for many different applications. Voltages are selected by applying jumpers (6) to the **voltage change-over board** (Figure 12). To obtain some of the voltages as listed in Table 7 (see below) will require a fine adjustment using the **voltage regulator (VR) control knob** located on the control panel.

### Voltage Change-Over Board

The **voltage change-over board** (Figure 12) is located on the control box, behind the generator control panel. This board has been provided for ease of voltage selection.

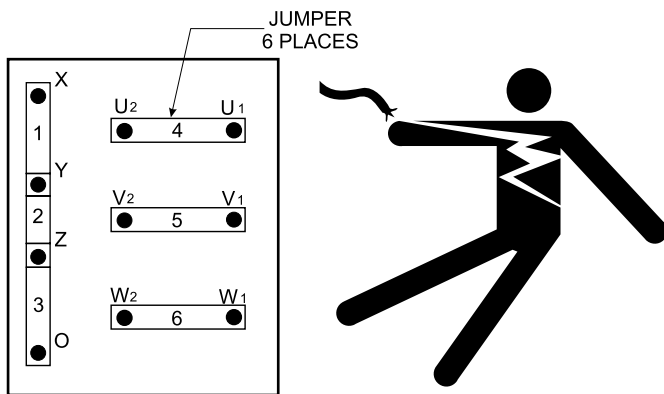

Figure 12. Voltage Change-Over Board

**CAUTION**

**NEVER** attempt to place jumper plates on the **voltage change-over board** while the generator is in operation. There exist the possibility of **electrocution, electrical shock or burn, which can cause severe bodily harm or even death!**

Table 7. Voltages Available						
UVW Output Terminal Lugs	Voltage Change-Over Board 3-Phase 240/139V Position			Voltage Change-Over Board 3-Phase 480/270V Position		
	3Ø Line-Line	208V	220V	240V	416V	440V
1Ø Line-Neutral	120V	127V	139V	240V	254V	277V
Voltage Change-Over Board Single-Phase 240/120V Position						
1Ø Line-Neutral/ Line-Line	120V Line-Neutral	N/A	N/A	240V Line-Line	N/A	N/A

## Maximum Amps

Table 8 shows the **maximum** amps the generator can provide. **DO NOT** exceed the maximum amps as listed.

Table 8. Generator Maximum Amps	
Model	MQP240
Rated Voltage	Maximum Amps
Single Phase 120 Volt	666.7 amps (4 wire)
Single Phase 240 Volt	333.3 amps (4 wire)
Three Phase 240 Volt	722 amps
Three Phase 480 Volt	361 amps



# GENERATOR OUTPUTS/GAUGE READING

## HOW TO READ THE AC AMMETER AND AC VOLTAGE GAUGES

The AC ammeter and AC voltmeter gauges are controlled by the AC ammeter and AC voltmeter change-over switches.

Both of these switches are located on the control panel and **DO NOT** effect the generator output. They are provided to help observe how much power is being supplied, produced at the UVWO terminals lugs.

Before taking a reading from either gauge, configure the **Voltage Change-Over Board** (Figure 13) which produces the desired output voltage.

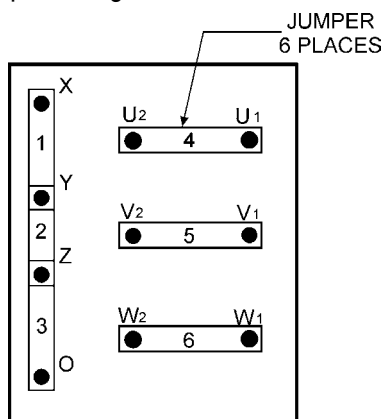

Figure 13. Voltage Change-Over Board  
240/3Ø Position

## AC Voltmeter Gauge Reading

Place the **AC Voltmeter Change-Over Switch** (Figure 14) in the W-U position and observe the phase to phase voltage reading between the W and U terminals as indicated on the **AC Voltmeter Gauge** (Figure 15).

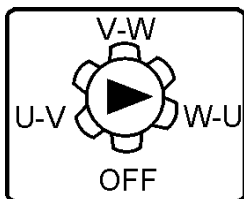

Figure 14. AC Voltmeter Change-Over Switch

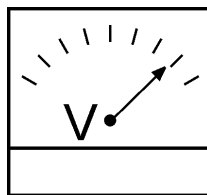

Figure 15. AC Voltmeter Gauge  
(Volt reading on W-U Lug)

## AC Ammeter Gauge Reading

Place the **AC Ammeter Change-Over Switch** (Figure 16) in the U position and observe the current reading (load drain) on the U terminal as indicated on the **AC Ammeter Gauge** (Figure 17). This process can be repeated for terminals V and W.

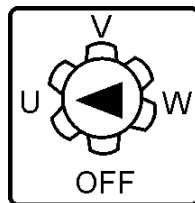

Figure 16. AC Ammeter Change-Over Switch

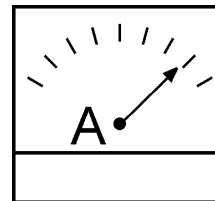

Figure 17. AC Ammeter  
(Amp reading on U Lug)

### NOTICE

The **ammeter** gauge will only show a reading when the **Output Terminal Lugs** are connected to a load and in use.

# OUTPUT TERMINAL PANEL CONNECTIONS

## UVWO TERMINAL OUTPUT VOLTAGES

Various output voltages can be obtained using the UVWO output terminal lugs. The voltages at the terminals are dependent on the placement of the jumpers plates (6) on the **Voltage Change-Over Board** and the adjustment of the **Voltage Regulator Control Knob**.

Remember the voltage change-over board determines the **range** of the output voltage and can be configured in two different positions that provide 6 different output voltages at the UVWO output terminals. The generator is shipped from the factory in the 240V configuration. The voltage regulator (VR) allows the user to increase or decrease the selected voltage.

### 3Ø-240V UVWO Terminal Output Voltages

1. Jumper the voltage change-over board for 240V operation as shown in Figure 18.

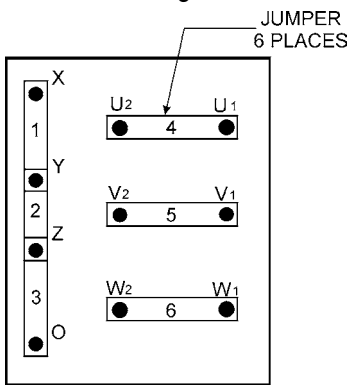

**Figure 18. Voltage Change-Over Board 240V Configuration**

2. Connect the load wires to the UVWO terminals as shown in Figure 19.

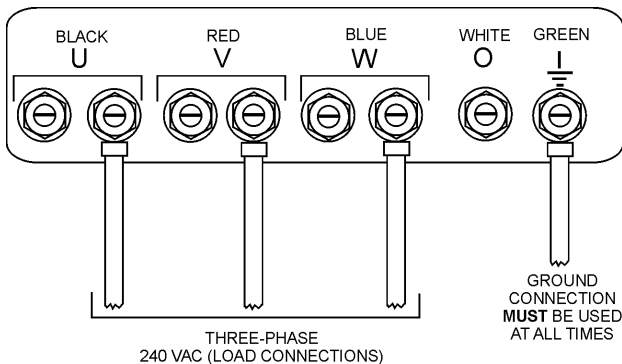

**Figure 19. UVWO Terminal Lugs**

3. Turn the voltage regulator knob (Figure 20) clockwise to increase voltage output, turn counterclockwise to decrease voltage output. Use voltage regulator adjustment knob whenever fine tuning of the output voltage is required.



**Figure 20. Voltage Regulator Knob**

### 1Ø-240V UVWO Terminal Output Voltages

1. Make sure the voltage change-over board is jumpered for 240V operation as shown in Figure 18.
2. Connect the load wires to the UVWO terminals as shown in Figure 21.

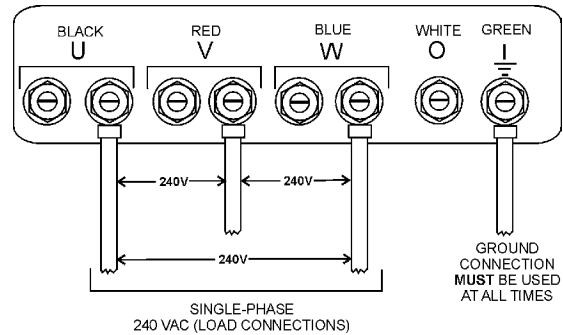

**Figure 21. UVWO Terminal Lugs 1Ø-240V Connections**

### 1Ø-120V UVWO Terminal Output Voltages

1. Make sure the voltage change-over board is jumpered for 240V operation as shown in Figure 18.
2. Adjust voltage regulator knob (Figure 20) for an output of 208V to obtain 120V at the UVWO terminals.
3. Connect the load wires to the UVWO terminals as shown in Figure 22.

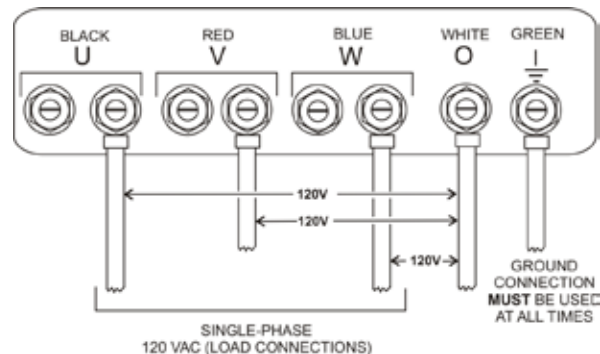
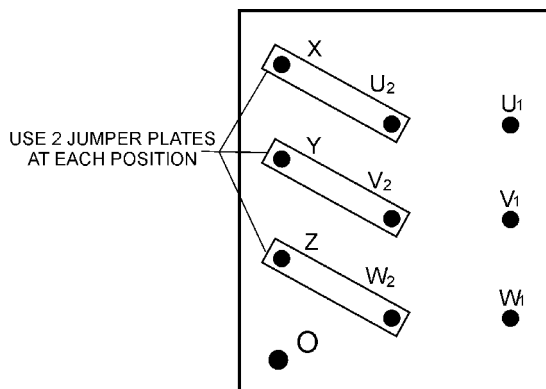

**Figure 22. UVWO Terminal Lugs 1Ø-120V Connections**

# OUTPUT TERMINAL PANEL CONNECTIONS

## 3Ø-480V UVW Terminal Output Voltages

1. Jumper the voltage change-over board for 480V operation as shown in Figure 23. This configuration uses 6 jumper plates in 3 different positions. Remember there are 2 jumper plates at every position. Every jumper plate **must** be used.



**Figure 23. Voltage Change-Over Board 480V Configuration**

2. Connect the load wires to the UVW terminals as shown in Figure 24.

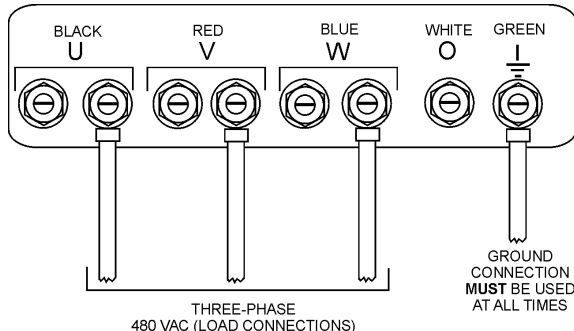

**Figure 24. UVW Terminal Lugs 3Ø-480V Connections**

### NOTICE

**ALWAYS** make sure that the connections to the UVW terminals are **secure** and **tight**. The possibility of arcing exists, that could cause a fire.

## 1Ø-480V UVW Terminal Output Voltages

1. Make sure the voltage change-over board is jumpered for 480V operation as shown in Figure 23.
2. Connect the load wires to the UVW terminals as shown in Figure 25.

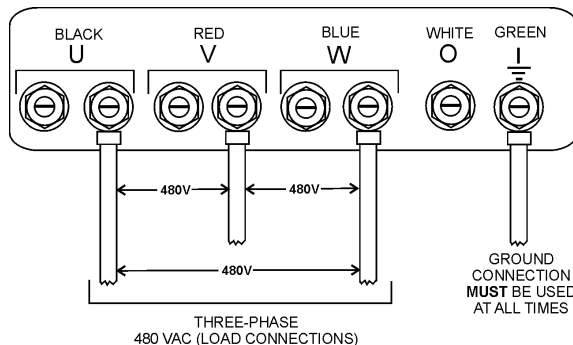

**Figure 25. UVW Terminal Lugs 1Ø-480V Connections**

## 1Ø-277V UVW Terminal Output Voltages

1. Make sure the voltage change-over board is jumpered for 480V operation as shown in Figure 23.
2. Connect the load wires to the UVW terminals as shown in Figure 26.

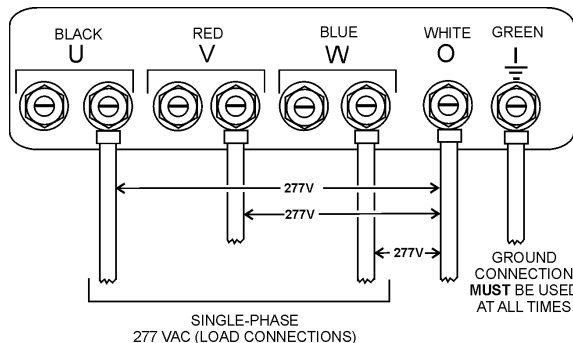

**Figure 26. UVW Terminal Lugs 1Ø-277V Connections**

## CIRCUIT BREAKERS

To protect the generator from an overload, a 3-pole, 800 amp, main circuit breaker is provided to protect the **U, V, and W Output Terminals** from overload. In addition two single-pole, 20 amp **GFCI** circuit breakers are provided to protect the GFCI receptacles from overload. Three 50 amp **load** circuit breakers have also been provided to protect the auxiliary receptacles from overload. Make sure to switch **ALL** circuit breakers to the **OFF** position prior to starting the engine.

## LUBRICATION OIL

Fill the engine crankcase with lubricating oil through the filler hole, but **DO NOT** overfill. Make sure the generator is level and verify that the oil level is maintained between the two notches (Figure 27) on the dipstick. See Table 9 for proper selection of engine oil.

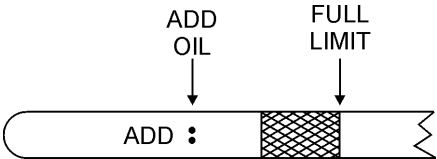

**Figure 27. Engine Oil Dipstick**

When checking the engine oil, be sure to check if the oil is clean. If the oil is not clean, drain the oil by removing the oil drain plug, and refill with the specified amount of oil as outlined in the **Cummins Engine Owner's Manual**. Oil should be warm before draining.

Other types of motor oils may be substituted if they meet the following requirements:

- API Service Classification CC/SC
- API Service Classification CC/SD
- API Service Classification CC/SE
- API Service Classification CC/SF

**Table 9. Recommended Motor Oil**

		OIL: SAE	
°F	°C		
122	50		
104	40	10W/40	30
86	30		
68	20		
50	10		
32	0	5W/30	10W/40
-14	-10		
-4	-20	ARCTIC OIL	15W/30
-22	-30		
-40	-40		
			10W/30
			10W
			20W/40

## FUEL CHECK

**! DANGER**



Fuel spillage on a **hot** engine can cause a **fire** or **explosion**. If fuel spillage occurs, wipe up the spilled fuel completely to prevent fire hazards. **NEVER** smoke around or near the generator.

## Refilling the Fuel System

**! CAUTION**

**ONLY** properly trained personnel who have read and understand this section should refill the fuel tank system.

This generator has an internal fuel tank located inside the trailer frame and may also be equipped with an environmental fuel tank (Figure 28). **ALWAYS** fill the fuel tanks with clean fresh **#2 diesel fuel**. **DO NOT** fill the fuel tanks beyond their capacities.

Pay attention to the fuel tank capacity when replenishing fuel. The fuel tank cap must be closed tightly after filling. Handle fuel in a safety container. If the container does not have a spout, use a funnel. Wipe up any spilled fuel immediately.

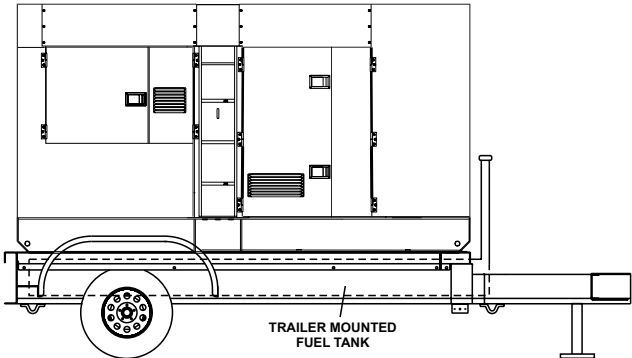

**Figure 28. Internal Fuel Tank System**

## Refueling Procedure:

**WARNING**



**Diesel fuel** and its vapors are dangerous to your health and the surrounding environment. Avoid skin contact and/or inhaling fumes.

1. **Level Tanks** — Make sure fuel cells are level with the ground. Failure to do so will cause fuel to spill from the tank before reaching full capacity (Figure 29).

**CAUTION**

**ALWAYS** place trailer on firm level ground before refueling to prevent spilling and maximize the amount of fuel that can be pumped into the tank.

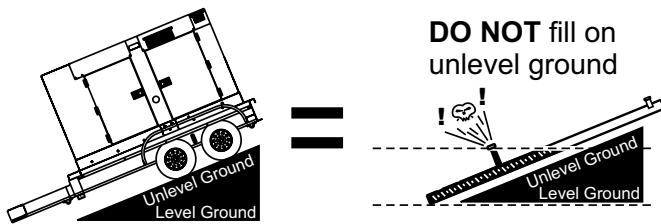

Figure 29. Only Fill on Level Ground

**NOTICE**

**ONLY** use #2 diesel fuel when refueling.

2. Remove fuel cap and fill tank (Figure 30).

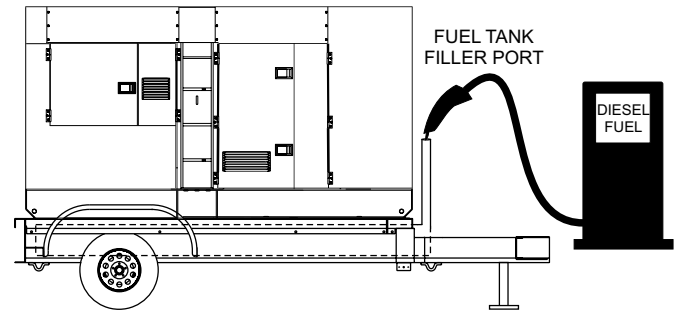

Figure 30. Fueling

3. **NEVER overfill fuel tank** — It is important to read the fuel gauge when filling trailer fuel tank. **DO NOT** wait for fuel to rise in filler neck (Figure 31).

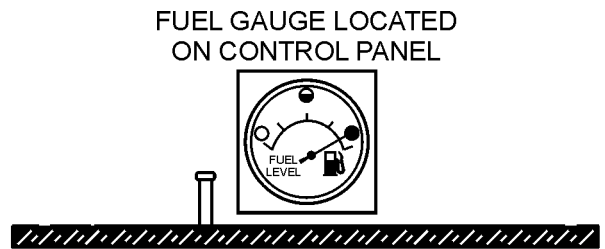

Figure 31. Full Fuel Tank

**CAUTION**

**DO NOT OVERFILL** fuel system. Leave room for fuel expansion. Fuel expands when heated (Figure 32).

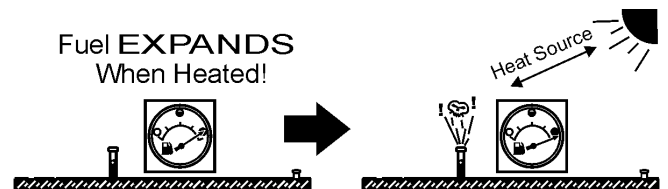



Figure 32. Fuel Expansion

## COOLANT (ANTIFREEZE/SUMMER COOLANT/WATER)

Cummins recommends antifreeze/summer coolant for use in their engines, which can be purchased in concentrate (and mixed with 50% demineralized water) or pre-diluted. See the **Cummins Engine Owner's Manual** for further details.

**WARNING**



If adding coolant/antifreeze mix to the radiator, **DO NOT** remove the radiator cap until the unit has completely cooled. The possibility of **hot!** coolant exists which can cause severe burns.

Day-to-day addition of coolant is done from the recovery tank. When adding coolant to the radiator, **DO NOT** remove the radiator cap until the unit has completely cooled. See Table 10 for engine, radiator, and recovery tank coolant capacities. Make sure the coolant level in the recovery tank is always between the "H" and the "L" markings.

Table 10. Coolant Capacity	
Engine and Radiator	11.3 Gal (43 liters)
Reserve Tank	N/A

## Operation in Freezing Weather

When operating in freezing weather, be certain the proper amount of antifreeze (Table 11) has been added.

Table 11. Anti-Freeze Operating Temperatures		
Vol % Anti-Freeze	Freezing Point	
	°C	°F
50	-37	-34

**NOTICE**

When the antifreeze is mixed with water, the antifreeze mixing ratio **must be** less than 50%.

## Cleaning the Radiator

The engine may overheat if the radiator fins become overloaded with dust or debris. Periodically clean the radiator fins with compressed air. Cleaning inside the machine is dangerous, so clean only with the engine turned off and the **negative** battery terminal disconnected.

## AIR CLEANER

Periodic cleaning/replacement is necessary. Inspect air cleaner in accordance with the **Cummins Engine Owner's Manual**.

## FAN BELT TENSION

A slack fan belt may contribute to overheating, or to insufficient charging of the battery. Inspect the fan belt for damage and wear and adjust it in accordance with the **Cummins Engine Owner's Manual**.

The fan belt tension is proper if the fan belt bends 10 to 15 mm (Figure 33) when depressed with the thumb as shown below.

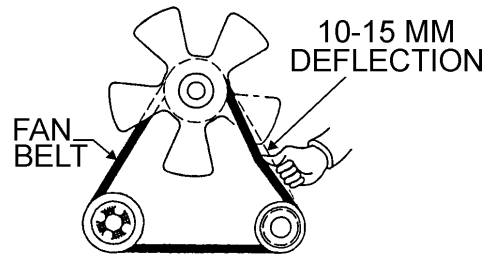



Figure 33. Fan Belt Tension

**CAUTION**



**NEVER** place hands near the belts or fan while the generator set is running.

## BATTERY

This unit is of negative ground **DO NOT** connect in reverse. Always maintain battery fluid level between the specified marks. Battery life will be shortened, if the fluid level are not properly maintained. Add only distilled water when replenishment is necessary.

**DO NOT** over fill. Check to see whether the battery cables are loose. Poor contact may result in poor starting or malfunctions. **Always** keep the terminals firmly tightened. Coating the terminals with an approved battery terminal treatment compound. Replace battery with only recommended type battery. The battery type used in this generator is BCI Group 27.

The battery is sufficiently charged if the specific gravity of the battery fluid is 1.28 (at 68° F). If the specific gravity should fall to 1.245 or lower, it indicates that the battery is dead and needs to be recharged or replaced.

Before charging the battery with an external electric source, be sure to disconnect the battery cables.

### Battery Cable Installation

ALWAYS be sure the battery cables (Figure 34) are properly connected to the battery terminals as shown below. The **red cable** is connected to the positive terminal of the battery, and the **black cable** is connected to the negative terminal of the battery.

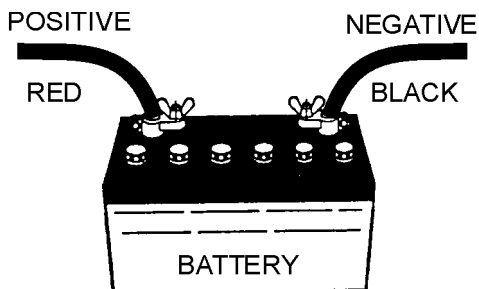
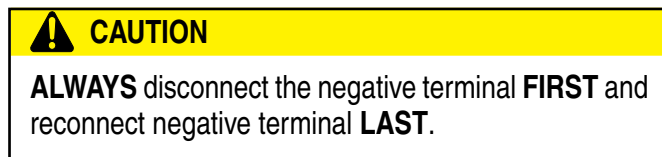

Figure 34. Battery Connections

When connecting battery do the following:

1. **NEVER** connect the battery cables to the battery terminals when the **MPEC Control Switch** is in either the **MANUAL** position. **ALWAYS** make sure that the **MPEC Control Switch** is in the **OFF/RESET** position when connecting the battery.
2. Place a small amount of battery terminal treatment compound around both battery terminals. This will ensure a good connection and will help prevent corrosion around the battery terminals.

### NOTICE

If the battery cable is connected incorrectly, electrical damage to the generator will occur. Pay close attention to the polarity of the battery when connecting the battery.

### CAUTION

Inadequate battery connections may cause poor starting of the generator, and create other malfunctions.

## ALTERNATOR

The polarity of the alternator is negative grounding type. When an inverted circuit connection takes place, the circuit will be in short circuit instantaneously resulting the alternator failure.

**DO NOT** put water directly on the alternator. Entry of water into the alternator can cause corrosion and damage the alternator.

## WIRING

Inspect the entire generator for bad or worn electrical wiring or connections. If any wiring or connections are exposed (insulation missing) replace wiring immediately.

## PIPING AND HOSE CONNECTION

Inspect all piping, oil hose, and fuel hose connections for wear and tightness. Tighten all hose clamps and check hoses for leaks.

If any hose (**fuel or oil**) lines are defective replace them immediately.

# GENERATOR START-UP PROCEDURE (MANUAL)

## BEFORE STARTING

### CAUTION

The engine's exhaust contains harmful emissions. **ALWAYS** have adequate ventilation when operating. Direct exhaust away from nearby personnel.

### WARNING

**NEVER** manually start the engine with the **main, GFCI or auxiliary** circuit breakers in the **ON** (closed) position.

1. Place the **main, G.F.C.I., and aux.** circuit breakers (Figure 35) in the **OFF** position prior to starting the engine.

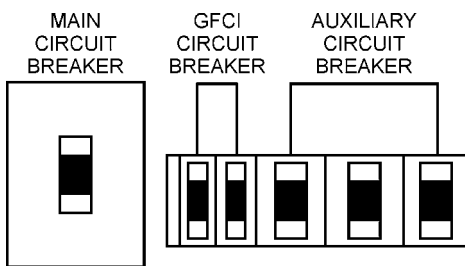

**Figure 35. Main, Aux. and GFCI Circuit Breakers (OFF)**

2. Make sure the **voltage change-over board** has been configured for the desired output voltage.
3. Connect the load to the **receptacles** or the **output terminal lugs** as shown in Figure 10. These load connection points can be found on the output terminal panel and the output terminal panel's hard wire hookup panel.
4. Tighten terminal nuts securely to prevent load wires from slipping out.
5. Close all engine enclosure doors (Figure 36).

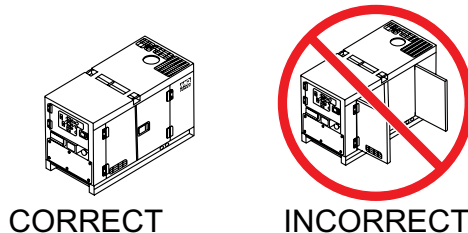

**Figure 36. Engine Enclosure Doors**

## STARTING (MANUAL)

1. Place the engine speed switch (Figure 37) in the **LOW** (down) position.



**Figure 37. Engine Speed Switch (Low)**

2. Place the **MPEC control switch** in the **MANUAL** position to start the engine (Figure 38).

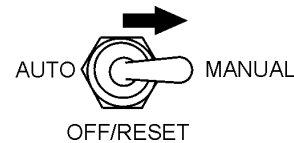

**Figure 38. MPEC Control Switch (Manual Position)**

3. Once the engine starts, let the engine run for 1-2 minutes. Listen for any abnormal noises. If any abnormalities exist, shut down the engine and correct the problem. If the engine is running smoothly, place the engine speed switch (Figure 39) in the **HIGH** (up) position.



**Figure 39. Engine Speed Switch (High)**

4. Verify that the **engine running status LED** on the MPEC unit (Figure 40) is **ON** (lit) after the engine has been started.

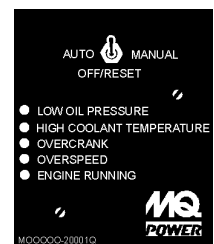
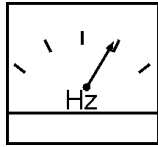

**Figure 40. Engine Running LED (ON)**



# GENERATOR START-UP PROCEDURE (MANUAL)

5. The generator's frequency meter (Figure 41) should be displaying the 60 cycle output frequency in **HERTZ**.



**Figure 41. Frequency Meter**

6. The generator's AC-voltmeter (Figure 42) will display the generator's output in **VOLTS**. If the voltage is not within the specified tolerance.

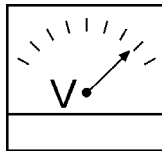

**Figure 42. Voltmeter**

7. Use the voltage adjustment control knob (Figure 43) to increase or decrease the desired voltage.

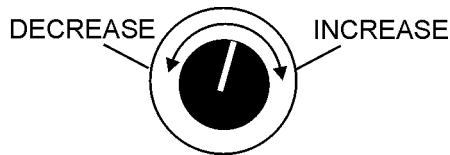

**Figure 43. Voltage Adjust Control Knob**

8. The ammeter (Figure 44) will indicate **zero amps** with no load applied. When a load is applied, the ammeter will indicate the amount of current that the load is drawing from the generator.

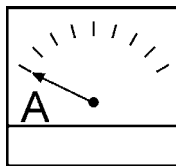

**Figure 44. Ammeter (No Load)**

9. The engine oil pressure gauge (Figure 45) will indicate the oil pressure of the engine. Under normal operating conditions the oil pressure is approximately 28 to 85 psi. (193~586 kPa).

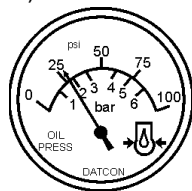

**Figure 45. Oil Pressure Gauge**

10. The **coolant temperature gauge** (Figure 46) will indicate the coolant temperature. Under normal operating conditions the coolant temperature should be between 167°~203°F (75°~95°C) (**Green Zone**).

**Figure 46. Coolant Temperature Gauge**

11. The **tachometer gauge** (Figure 47) will indicate the speed of the engine when the generator is operating. Under normal operating conditions this speed is approximately 1800 RPM's.



**Figure 47. Engine Tachometer Gauge**

12. Place the **main, GFCI, and aux.** circuit breakers in the **ON** position (Figure 48).

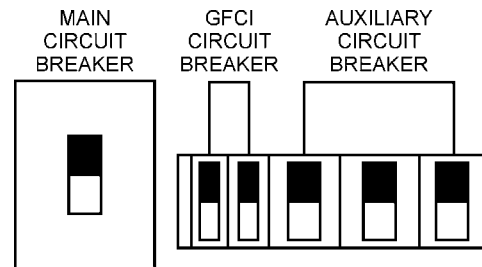

**Figure 48. Main, Aux. and GFCI Circuit Breakers (ON)**

13. Observe the generator's ammeter (Figure 49) and verify it reads the anticipated amount of current with respect to the load. The ammeter will only display a current reading if a load is in use.

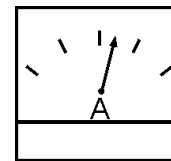

**Figure 49. Ammeter (Load)**

14. The generator will run until manually stopped or an abnormal condition occurs.

# GENERATOR START-UP PROCEDURE (AUTO MODE)

## STARTING (AUTO MODE)

### DANGER



Before connecting this generator to any building's electrical system, a **licensed electrician** must install an **isolation (transfer) switch**. Serious damage to the building's electrical system may occur without this transfer switch.

### CAUTION

When connecting the generator to a isolation (transfer) switch, **ALWAYS** have power applied to the generator's internal battery charger. This will ensure that the engine will not fail due to a dead battery.

### NOTICE

When the generator is set in the **AUTO** mode, the generator will **automatically start** in the event of commercial power falling below a prescribed level by means of a contact closure that is generated automatically by a transfer switch.

### WARNING

When running the generator in the **AUTO** mode, remember the generator can start up at any time without warning. **NEVER** attempt to perform any maintenance when the generator is in the auto mode.

### CAUTION

The engine speed switch **must** be set to the "High" position when running in the **auto-start** mode. Failing to set the switch in the proper position can result in damage to your generator when it turns on.

### NOTICE

When the MPEC control switch is placed in the **AUTO** position, the engine glow plugs will be warmed and the engine will start automatically.

When starting generator in **AUTO** mode use the "Manual Start-up" procedure except where noted (see below).

1. Perform steps 1 through 5 in the Before Starting section as outlined in the Manual Starting Procedure.
2. Place the **engine speed switch** (Figure 50) in the **HIGH** position

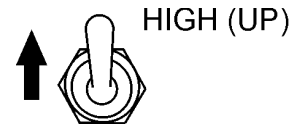

**Figure 50. Engine Speed Switch (High)**

3. Place the **MPEC Control Switch** (Figure 51) in the **AUTO** position.



**Figure 51. MPEC Control Switch (AUTO)**

4. Continue operating the generator as outlined in the Manual Start-up procedure (start at step 5).

# GENERATOR SHUT-DOWN PROCEDURES

## **WARNING**

**NEVER** stop the engine suddenly except in an emergency.

## NORMAL SHUTDOWN PROCEDURE

To shutdown the generator, use the following procedure:

1. Place both the **MAIN, GFCI and LOAD** circuit breakers as shown in Figure 35 to the **OFF** position.
2. Place the engine speed switch (Figure 52) in the “LOW” (down) position.



**Figure 52. Engine Speed Switch (Low)**

3. Let the engine cool by running it at low speed for 3-5 minutes with no load applied.
4. Place the **MPEC Control Switch** (Figure 53) to the **OFF/RESET** position.

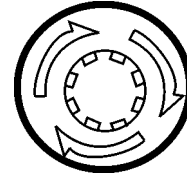

**Figure 53. MPEC Control Switch (Off/Reset)**

5. Verify that **all** the status LEDs on the MPEC display are **OFF** (not lit).
6. Remove all loads from the generator.
7. Inspect entire generator for any damage or loosening of components that may have occurred during operation.

## EMERGENCY SHUTDOWN PROCEDURE

1. To stop the engine in the event of an emergency, **PUSH** the emergency stop button (Figure 54) inward. This button is located on the engine operating panel, see Figure 5.



**Figure 54. Emergency Stop Button**

Table 12. Inspection/Maintenance		10 Hrs DAILY	250 Hrs	500 Hrs	1000 Hrs
<b>Engine</b>	Check Engine Fluid Levels	X			
	Check Air Cleaner	X			
	Check Battery Acid Level	X			
	Check Fan Belt Condition	X			
	Check for Leaks	X			
	Check for Loosening of Parts	X			
	Replace Engine Oil and Filter * 1		X		
	Clean Air Filter		X		
	Check Fuel Filter/Water Separator Bowl	X			
	Clean Unit, Inside and Outside		X		
	Change Fuel Filter			X	
	Clean Radiator and Check Coolant Protection Level*2			X	
	Replace Air Filter Element * 3			X	
	Check all Hoses and Clamps * 4				X
<b>Generator</b>	Measure Insulation Resistance Over 3M ohms		X		
	Check Rotor Rear Support Bearing			X	

\*1 Replace engine oil and filter at 100 hours, first time only.

\*2 Add "Supplemental Coolant Additives (SCA'S)" to recharge the engine coolant.

\*3 Replace primary air filter element when restriction indicator shows a vacuum of 625 mm (25 in. H2O).

\*4 If blowby hose needs to be replaced, ensure that the slope of the blowby hose is at least a 1/2 inch per foot, with no sags or dips that could collect moisture and/or oil.

## GENERAL INSPECTION

Prior to each use, the generator should be cleaned and inspected for deficiencies. Check for loose, missing or damaged nuts, bolts or other fasteners. Also check for fuel, oil, and coolant leaks. Use Table 12 as a general maintenance guideline **Engine Side** (Refer to the Engine Instruction Manual).

## AIR CLEANER

Every 250 hours: Remove air cleaner element (Figure 55) and clean the heavy duty paper element with light spray of compressed air. Replace the air cleaner as needed.

### Air Cleaner with Dust Indicator

This indicator (Figure 55) is attached to the air cleaner. When the air cleaner element is clogged, air intake restriction becomes greater and the dust indicator signal shows **RED** meaning the element needs changing or service. After changing the air element, press the dust indicator button to reset the indicator.

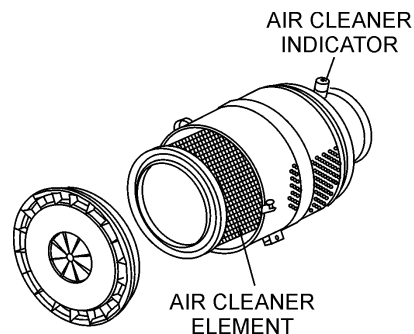

**Figure 55. Air Cleaner/Indicator**

### NOTICE

The air filter should not be changed until the indicator reads "**RED**". Dispose of old air filter. It may not be cleaned or reused.

If the engine is operating in very **dusty** or **dry grass** conditions, a clogged air cleaner will result. This can lead to a loss of power, excessive carbon buildup in the combustion chamber and high fuel consumption. Change air cleaner more **frequently** if these conditions exist.

## FUEL ADDITION

Add diesel fuel (the grade may vary according to season and locations).

## Removing Water from the Fuel Tank

After prolonged use, water and other impurities accumulate in the bottom of the tank. Occasionally inspect the fuel tank for water contamination and drain the contents if required.

During cold weather, the more empty volume inside the tank, the easier it is for water to condense. This can be reduced by keeping the tank full with diesel fuel.

## CLEANING INSIDE THE FUEL TANK

Drain the fuel inside the fuel tank completely. Using a spray washer (Figure 56) wash out any deposits or debris that have accumulated inside the fuel tank.

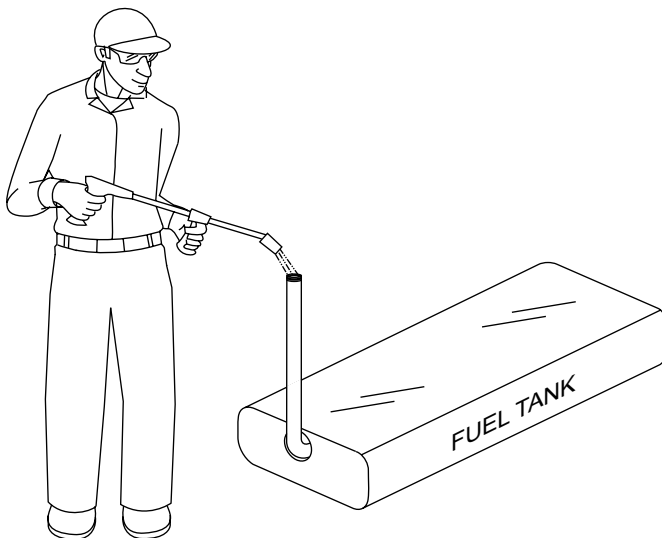

Figure 56. Fuel Tank Cleaning

## FUEL TANK INSPECTION

In addition to cleaning the fuel tank, the following components should be inspected for wear:

- **Rubber Suspension** — look for signs of wear or deformity due to contact with oil. Replace the rubber suspension if necessary.
- **Fuel Hoses** — inspect nylon and rubber hoses for signs of wear, deterioration and hardening.
- **Fuel Tank Lining** — inspect the fuel tank lining for signs of excessive amounts of oil or other foreign matter.

## Replacing Fuel Filter

- Replace the fuel filter cartridge with new one every 500 hours or so.
- Loosen the drain plug at the lower top of the fuel filter. Drain the fuel in the fuel body together with the mixed water. **DO NOT** spill the fuel during disassembly.
- Vent any air

## AIR REMOVAL

If air enters the fuel injection system of a diesel engine, starting becomes impossible. After running out of fuel, or after disassembling the fuel system, bleed the system according to the following procedure. See the **Cummins Engine Manual** for details.

To restart after running out of fuel, turn the switch to the "ON" position for 15-30 seconds. Try again, if needed. This unit is equipped with an automatic air bleeding system.

## CHECK OIL LEVEL

Check the crankcase oil level prior to each use, or when the fuel tank is filled. Insufficient oil may cause severe damage to the engine. Make sure the generator is level. The oil level must be between the two notches on the dipstick as shown in Figure 27.

## Replacing Oil Filter

- Remove the old oil filter.
- Apply a film of oil to the gasket on the new oil filter.
- Install the new oil filter.
- After the oil cartridge has been replaced, the engine oil will drop slightly. Run the engine for a while and check for leaks before adding more oil if needed. Clean excessive oil from engine.

## FLUSHING OUT RADIATOR AND REPLACING COOLANT

- Open both cocks located at the crankcase side and at the lower part of the radiator and drain coolant. Open the radiator cap while draining. Remove the overflow tank and drain.
- Check hoses for softening and kinks. Check clamps for signs of leakage.
- Tighten both cocks and replace the overflow tank.
- Replace with coolant as recommended by the engine manufacturer.
- Close radiator cap tightly.
- Flush the radiator by running clean tap water through radiator until signs of rust and dirt are removed. **DO NOT** clean radiator core with any objects, such as a screwdriver.

**WARNING**



Allow engine to **cool** when flushing out radiator. Flushing the radiator while hot could cause serious burns from water or steam.

## RADIATOR CLEANING

The radiator (Figure 57) should be sprayed (cleaned) with a high pressure washer when excessive amounts of dirt and debris have accumulated on the cooling fins or tube. When using a high pressure washer, stand at least 5 feet (1.5 meters) away from the radiator to prevent damage to the fins and tube.

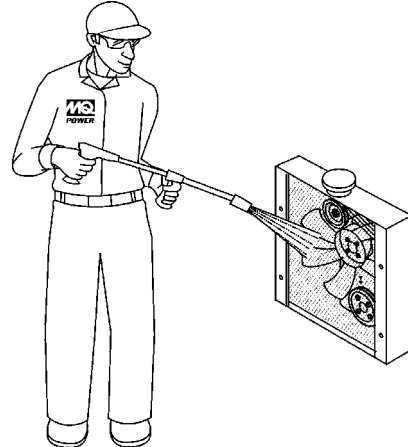

Figure 57. Radiator Cleaning

## GENERATOR STORAGE

For long term storage of the generator the following is recommended:

- Drain the fuel tank completely. Treat with a fuel stabilizer if necessary.
- Completely drain the oil from the crankcase and refill if necessary with fresh oil.
- Clean the entire generator, internal and external.
- Cover the generating set and store in a clean, dry place.
- Disconnect the battery.
- Make sure engine coolant is at proper level.
- If generator is mounted on a trailer, jack trailer up and place on blocks so tires do not touch the ground or block and completely remove the tires.

## JACKET WATER HEATER AND INTERNAL BATTERY CHARGER 120 VAC INPUT RECEPTACLES (OPTIONAL)

This generator can be optionally equipped with two 120 VAC, 20 amp input receptacles located on the output terminal panel.

The purpose of these receptacles is to provide power via commercial power to the **jacket water heater** and **internal battery charger**.

These receptacles will **ONLY** function when commercial power has been supplied to them (Figure 58). To apply commercial power to these receptacles, a power cord of adequate size will be required (See Table 6).

When using the generator in **hot** climates there is no reason to apply power to jacket water heater. However, if the generator will be used in **cold** climates it is always a good idea to apply power to the jacket water heater at all times. To apply power to the jacket water heater simply apply power to the jacket water heater receptacle via commercial power using an power cord of adequate size.

If the generator will be used daily, the battery should normally not require charging. If the generator will be idle (not used) for long periods of time, apply power to the battery charger receptacle via commercial power using a power cord of adequate size.

### NOTICE

If the generator will be idle (not used) for long periods of time and to ensure adequate starting capability, always have power applied to the generator's internal battery charger.

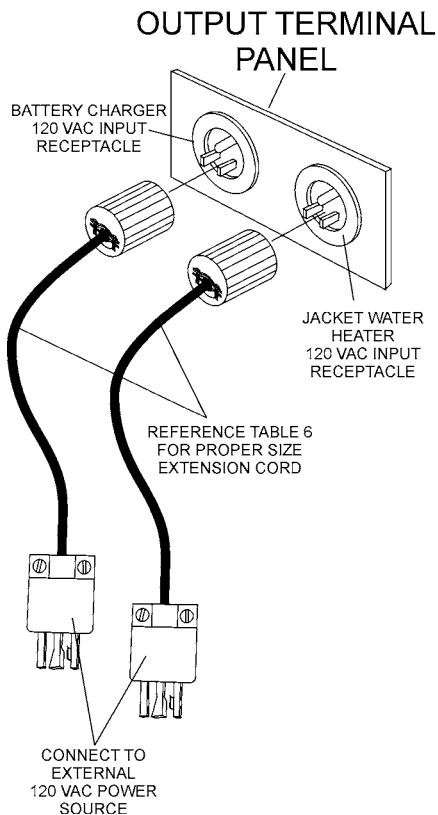

**Figure 58. Battery Charger and Jacket Water Heater Power Connections**

# GENERATOR WIRING DIAGRAM

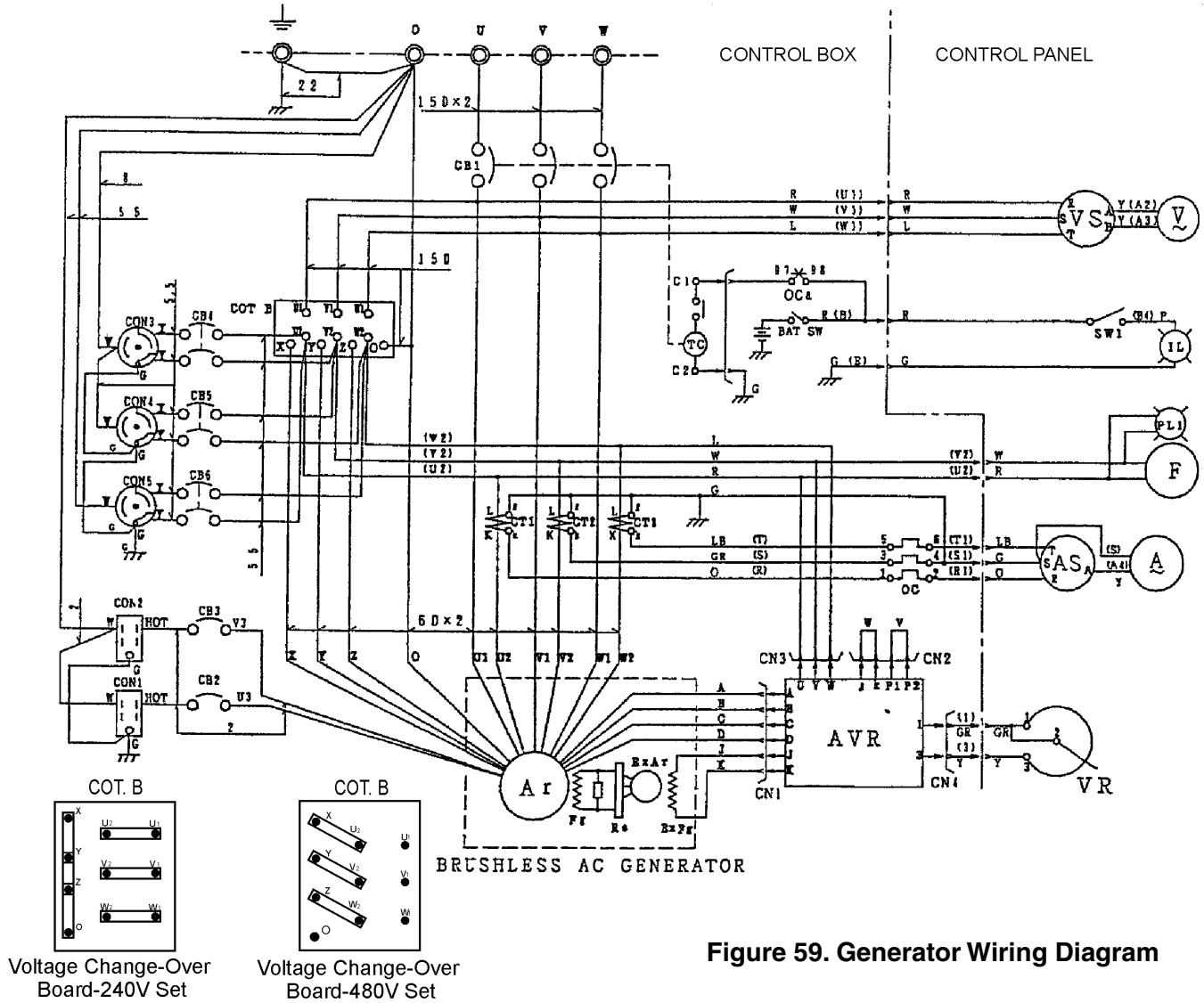
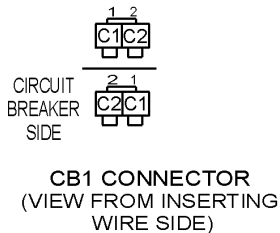
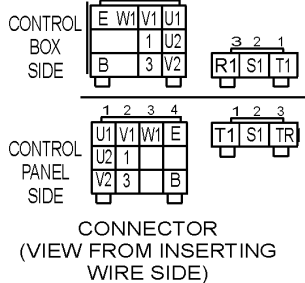
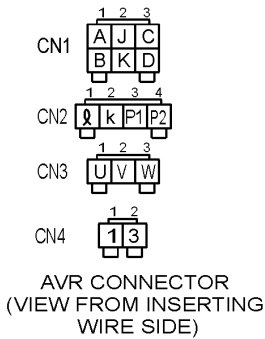

Figure 59. Generator Wiring Diagram



COLOR CODE		
WIRE COLOR	WIRE COLOR	WIRE COLOR
B BLACK	R RED	
L BLUE	W WHITE	
BR BROWN	Y YELLOW	
G GREEN	LB LIGHT BLUE	
GR GRAY	LG LIGHT GREEN	
V VIOLET	O ORANGE	
P PINK		

SYMBOL	DESIGNATION	SYMBOL	DESIGNATION
Ar	ARMATURE WINDING	A	AC AMMETER 0-750, 1,500A
Fg	MAIN GENERATOR FIELD WINDING	VS	VOLTMETER CHANGE-OVER SWITCH
Ex Ar	EXCITER ARMATURE WINDING	V	AC VOLTMETER 0-600V
Ex Fg	EXCITER FIELD WINDING	F	FREQUENCY METER 45-65 Hz
AVR	AUTOMATIC VOLTAGE REGULATOR	PL1	PILOT LAMP
VR	VOLTAGE REGULATING RHEOSTAT	CB2-3	AUX. CIRCUIT BREAKER 20A
Re	RECTIFIER	CB4-6	AUX. CIRCUIT BREAKER 50A
CT1-3	CURRENT TRANSFORMER 750/5A	CON2-3	RECEPTACLE 520R GFCI 20A, 125V
CB1	CIRCUIT BREAKER 800 AMPS	CON3-5	RECEPTACLE CS-6369 50A, 120/240V
OC	OVER CURRENT RELAY	IL	PANEL LIGHT
COT. B	VOLTAGE CHANGE-OVER BOARD	SW1	PANEL LIGHT SWITCH
AS	AMMETER CHANGE-OVER SWITCH		



# ENGINE WIRING DIAGRAM

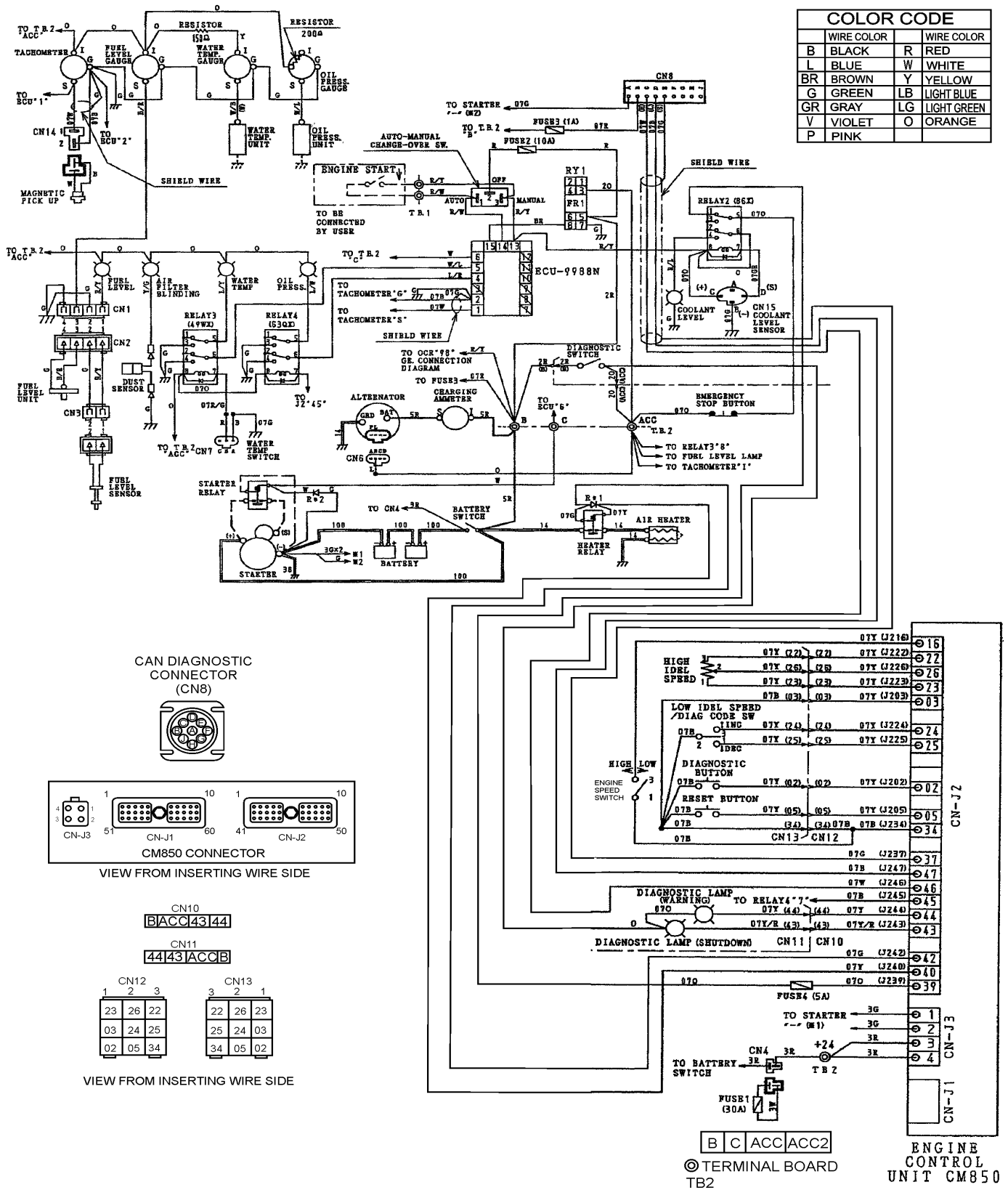

Figure 60. Engine Wiring Diagram

## TROUBLESHOOTING (GENERATOR)

Practically all breakdowns can be prevented by proper handling and maintenance inspections, but in the event of a breakdown, use Table 13 shown below for diagnosis of the Generator. If the problem cannot be remedied, consult our company's business office or service plant.

<b>Table 13. Generator Troubleshooting</b>		
<b>Symptom</b>	<b>Possible Problem</b>	<b>Solution</b>
No Voltage Output	AC Voltmeter defective?	Check output voltage using a voltmeter.
	Is wiring connection loose?	Check wiring and repair.
	Is AVR defective?	Replace if necessary.
	Defective Rotating Rectifier?	Check and replace.
	Defective Exciter Field?	Check for approximately 19 ohms across J & K on CN1
Low Voltage Output	Is engine speed correct?	Turn engine throttle lever to "High".
	Is wiring connections loose?	Check wiring and repair.
	Defective AVR?	Replace if necessary.
High Voltage Output	Is wiring connections loose?	Check wiring and repair.
	Defective AVR?	Replace if necessary.
Circuit Breaker Tripped	Short Circuit in load?	Check load and repair.
	Over current?	Confirm load requirements and reduce.
	Defective circuit breaker?	Check and replace.
	Over current Relay actuated?	Confirm load requirement and replace.

## TROUBLESHOOTING (ENGINE CONTROLLER)

Practically all breakdowns can be prevented by proper handling and maintenance inspections, but in the event of a breakdown, use Table 14 (Engine Controller Troubleshooting) as a basic guideline for troubleshooting the Microprocessor Engine Controller unit (MPEC). If the problem cannot be remedied, consult our company's business office or service plant.

<b>Table 14. Engine Controller Troubleshooting (MPEC)</b>		
Symptom	Possible Problem	Solution
Low oil pressure light is on.	Low oil level?	Fill oil level.
	Oil pressure sending unit failure?	Replace oil pressure sending unit.
	Time delay malfunction in controller?	Refer to dealer.
	Wire shorted?	Inspect/repair wire.
Low coolant level light is on. (Optionally installed)	Low coolant level?	Fill coolant level.
	Sending unit failure?	Replace sending unit.
	Low battery voltage?	Replace/charge battery.
High coolant temperature light is on.	Fan belt tension incorrect?	Tighten/replace fan belt.
	Air flow is not circulating through radiator?	Clean/repair radiator grill.
	Doors open?	Close doors.
	Exhaust leaking?	Replace/repair gaskets or faulty part.
	Generator being overloaded?	Check/reduce load.
	Thermostat failure?	Replace thermostat.
	Air intake blocked?	Clean all air intakes.
Overcrank light is on.	Temperature switch failure	Replace temperature switch.
	No or low fuel?	Fill fuel level.
Overspeed light is on.	Controller needs to be calibrated?	Refer to dealer.
	RPM engine speed too high?	Adjust RPM.
	Governor actuator needs to be adjusted?	Adjust governor actuator.
	Governor controller needs to be adjusted?	Adjust governor controller.
Loss of MPU light(s) or on.	Engine controller needs to be calibrated?	Refer to dealer.
	Magnetic pick up out of adjustment?	Adjust magnetic pick up.
	Magnetic pick up dirty?	Clean magnetic pick up.

## TROUBLESHOOTING (DIAGNOSTIC LAMP)

The engine controller of this generator diagnoses problems that arise from the engine control system and the engine itself. Press the diagnostic button (Figure 61) on the diagnostic panel to determine if an engine malfunction has occurred.

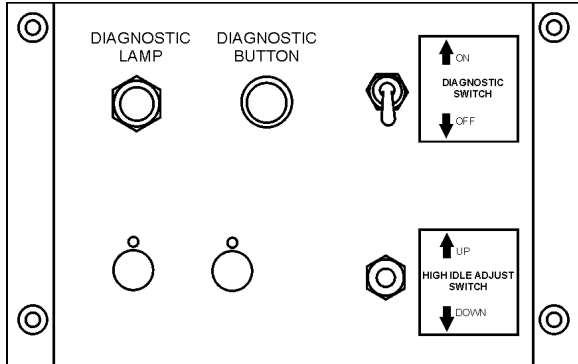

Figure 61. Diagnostic Panel

### METHOD OF OPERATION

1. Normally, the diagnostic lamp will be **dimly** lit when the **MPEC Control Switch** is placed in the **MANUAL** position.
2. If engine trouble occurs, the diagnostic lamp will be **brightly** lit as long as the control switch is left in the manual position.
3. The diagnostic lamp will indicate that an engine malfunction has occurred.

#### NOTICE

For a complete understanding of error codes and troubleshooting procedures, refer to the enclosed engine instruction manual

#### NOTICE

If the engine is cranked while the diagnostic switch is in the "ON" position, the engine will not be stopped even if the starter switch is turned to the "OFF" position. In such case, turn the diagnostic switch to the "OFF" position.



# OPERATION MANUAL

## HERE'S HOW TO GET HELP

PLEASE HAVE THE MODEL AND SERIAL  
NUMBER ON-HAND WHEN CALLING

### UNITED STATES

#### ***Multiquip Corporate Office***

18910 Wilmington Ave.  
Carson, CA 90746  
Contact: mq@multiquip.com

Tel. (800) 421-1244  
Fax (310) 537-3927

#### ***Service Department***

800-421-1244  
310-537-3700

#### ***Technical Assistance***

800-478-1244

Fax: 310-943-2238

#### ***MQ Parts Department***

800-427-1244  
310-537-3700

Fax: 800-672-7877

#### ***Warranty Department***

800-421-1244  
310-537-3700

Fax: 310-943-2249

### CANADA

#### ***Multiquip***

4110 Industriel Boul.  
Laval, Quebec, Canada H7L 6V3  
Contact: infocanda@multiquip.com

Tel: (450) 625-2244  
Tel: (877) 963-4411  
Fax: (450) 625-8664

### UNITED KINGDOM

#### ***Multiquip (UK) Limited Head Office***

Unit 2, Northpoint Industrial Estate,  
Globe Lane,  
Dukinfield, Cheshire SK16 4UJ  
Contact: sales@multiquip.co.uk

Tel: 0161 339 2223  
Fax: 0161 339 3226

© COPYRIGHT 2018, MULTIQUIP INC.

Multiquip Inc, the MQ logo and the MQ Power logo are registered trademarks of Multiquip Inc. and may not be used, reproduced, or altered without written permission. All other trademarks are the property of their respective owners and used with permission.

This manual MUST accompany the equipment at all times. This manual is considered a permanent part of the equipment and should remain with the unit if resold.

The information and specifications included in this publication were in effect at the time of approval for printing. Illustrations, descriptions, references and technical data contained in this manual are for guidance only and may not be considered as binding. Multiquip Inc. reserves the right to discontinue or change specifications, design or the information published in this publication at any time without notice and without incurring any obligations.

Your Local Dealer is:

Manufactured for  
MQ Power Inc.  
by  
DENYO CO., LTD, JAPAN

